

Trademarks

Autel® and MaxiIM®, MaxiSys®, MaxiDAS®, MaxiScan®, MaxiTPMS®, MaxiRecorder®, and MaxiCheck® are trademarks of Autel Intelligent Technology Corp., Ltd., registered in China, the United States and other countries. All other marks are trademarks or registered trademarks of their respective holders.

Copyright Information

No part of this manual may be reproduced, stored in a retrieval system or transmitted, in any form or by any means, electronic, mechanical, photocopying, recording, or otherwise without the prior written permission of Autel.

Disclaimer of Warranties and Limitation of Liabilities

All information, specifications and illustrations in this manual are based on the latest information available at the time of printing.

Autel reserves the right to make changes at any time without notice. While information of this manual has been carefully checked for accuracy, no guarantee is given for the completeness and correctness of the contents, including but not limited to the product specifications, functions, and illustrations.

Autel will not be liable for any direct, special, incidental, indirect damages or any economic consequential damages (including the loss of profits).

IMPORTANT

Before operating or maintaining this unit, please read this manual carefully, paying extra attention to the safety warnings and precautions.

For Services and Support



pro.autel.com

www.autel.com



1-855-288-3587 (North America)

+86 (0755) 8614-7779 (China)



support@autel.com

For technical assistance in all other markets, please contact your local selling agent.

Safety Information

For your own safety and the safety of others, and to prevent damage to the device and vehicles upon which it is used, it is important that the safety instructions presented throughout this manual be read and understood by all persons operating or coming into contact with the device.

There are various procedures, techniques, tools, and parts for servicing vehicles, as well as in the skill of the person doing the work. Because of the vast number of test applications and variations in the products that can be tested with this equipment, we cannot possibly anticipate or provide advice or safety messages to cover every circumstance. It is the automotive technician's responsibility to be knowledgeable of the system being tested. It is crucial to use proper service methods and test procedures. It is essential to perform tests in an appropriate and acceptable manner that does not endanger your safety, the safety of others in the work area, the device being used, or the vehicle being tested.

Before using the device, always refer to and follow the safety messages and applicable test procedures provided by the manufacturer of the vehicle or equipment being tested. Use the device only as described in this manual. Read, understand, and follow all safety messages and instructions in this manual.

Safety Messages

Safety messages are provided to help prevent personal injury and equipment damage. All safety messages are introduced by a signal word indicating the hazard level.

DANGER

Indicates an imminently hazardous situation which, if not avoided, will result in death or serious injury to the operator or to bystanders.

WARNING

Indicates a potentially hazardous situation which, if not avoided, could result in death or serious injury to the operator or to bystanders.

Safety Instructions

The safety messages herein cover situations Autel is aware of. Autel cannot know, evaluate or advise you as to all of the possible hazards. You must be certain that any conditions or service procedure encountered does not jeopardize your personal safety.

DANGER

When an engine is operating, keep the service area **WELL VENTILATED** or attach a building exhaust removal system to the engine exhaust system. Engines produce carbon monoxide, an odorless, poisonous gas that causes slower reaction time and can lead to serious personal injury or loss of life.

SAFETY WARNINGS

- Always perform automotive testing in a safe environment.
- Wear safety eye protection that meets ANSI standards.
- Keep clothing, hair, hands, tools, test equipment, etc. away from all moving or hot engine parts.
- Operate the vehicle in a well-ventilated work area, for exhaust gases are poisonous.
- Put the transmission in PARK (for automatic transmission) or NEUTRAL (for manual transmission) and make sure the parking brake is engaged.
- Put blocks in front of the drive wheels and never leave the vehicle unattended while testing.
- Be extra cautious when working around the ignition coil, distributor cap, ignition wires and spark plugs. These components create hazardous voltages when the engine is running.
- Keep a fire extinguisher suitable for gasoline, chemical, and electrical fires nearby.
- Do not connect or disconnect any test equipment while the ignition is on or the engine is running.
- Keep the test equipment dry, clean, free from oil, water or grease. Use a mild detergent on a clean cloth to clean the outside of the equipment as necessary.
- Do not drive the vehicle and operate the test equipment at the same time. Any distraction may cause an accident.
- Refer to the service manual for the vehicle being serviced and adhere to all diagnostic procedures and precautions. Failure to do so may result in personal injury or damage to the test equipment.
- To avoid damaging the test equipment or generating false data, make sure the vehicle battery is fully charged and the connection to the vehicle DLC is clean and secure.
- Do not place the test equipment on the distributor of the vehicle. Strong electro-magnetic interference can damage the equipment.

CONTENTS

| | |
|---|----|
| 1. USING THIS MANUAL | 1 |
| CONVENTIONS | 1 |
| 2. GENERAL INTRODUCTION | 2 |
| MAXIIM IM508 TABLET | 2 |
| XP200 | 6 |
| 3. GETTING STARTED | 11 |
| POWERING UP | 11 |
| POWERING DOWN..... | 14 |
| 4. IMMO | 15 |
| GETTING STARTED | 15 |
| VEHICLE IDENTIFICATION | 16 |
| NAVIGATION | 18 |
| IMMO | 21 |
| 5. PROGRAMMING | 28 |
| PROGRAMMING..... | 28 |
| 6. DIAGNOSTICS | 31 |
| DIAGNOSIS..... | 31 |
| GENERIC OBDII OPERATIONS | 41 |
| EXITING DIAGNOSTICS..... | 45 |
| 7. SERVICE | 46 |
| OIL RESET SERVICE | 46 |
| ELECTRONIC PARKING BRAKE (EPB) SERVICE | 48 |
| BMS | 52 |
| STEERING ANGLE SENSOR (SAS) SERVICE | 57 |
| DPF SERVICE | 59 |
| TIRE PRESSURE MONITOR SYSTEM (TPMS) SERVICE | 65 |
| 8. UPDATE | 68 |
| 9. SETTINGS..... | 70 |
| UNIT..... | 70 |
| LANGUAGE | 71 |
| PRINTING SETTINGS..... | 71 |

| | |
|-----------------------------------|----|
| REPORT SETTINGS | 72 |
| FIRMWARE UPGRADE | 72 |
| MULTITASK | 72 |
| AUTO UPDATE | 72 |
| CAR ORDER | 73 |
| SYSTEM SETTINGS..... | 73 |
| ABOUT..... | 74 |
| 10. REMOTE DESK..... | 75 |
| 11. DATA MANAGER | 77 |
| OPERATIONS | 77 |
| 12. SHOP MANAGER | 82 |
| VEHICLE HISTORY..... | 83 |
| WORKSHOP INFORMATION | 85 |
| CUSTOMER MANAGER..... | 85 |
| 13. FUNCTION VIEWER | 87 |
| 14. SUPPORT | 89 |
| PRODUCT REGISTRATION | 89 |
| SUPPORT SCREEN LAYOUT..... | 90 |
| MY ACCOUNT..... | 90 |
| COMMUNITIES | 91 |
| DATA LOGGING..... | 92 |
| TRAINING | 92 |
| FAQ | 92 |
| 15. ACADEMY | 93 |
| 16. QUICK LINK | 94 |
| 17. MAINTENANCE AND SERVICE | 95 |
| MAINTENANCE INSTRUCTIONS | 95 |
| TROUBLESHOOTING CHECKLIST | 96 |
| ABOUT BATTERY USAGE | 97 |
| 18. COMPLIANCE INFORMATION | 98 |
| FCC COMPLIANCE..... | 98 |
| SAR | 99 |
| RF WARNING STATEMENT | 99 |

| | |
|----------------------|-----|
| RoHS COMPLIANCE..... | 99 |
| CE COMPLIANCE | 99 |
| 19. WARRANTY | 100 |

1. Using this Manual

This manual contains device usage instructions.

Some illustrations shown in this manual may contain modules and optional equipment that are not included in your system.

Conventions

The following conventions are used.

Bold Text

Bold text is used to highlight selectable items such as buttons and menu options.

Example:

- Tap **OK**.

Notes and Important Messages

Notes

A **NOTE** provides helpful information such as additional explanations, tips, and comments.

Important

IMPORTANT indicates a situation which, if not avoided, may result in damage to the tablet or vehicle.

Hyperlink

Hyperlinks are available in electronic documents. Blue italic text indicates a selectable hyperlink and blue underlined text indicates a website link or an email address link.

Illustrations

Illustrations used in this manual are samples, the actual testing screen may vary for each vehicle being tested. Observe the menu titles and on-screen instructions to make correct option selection.

2. General Introduction

When it comes to ultra-portability, MaxiIM IM508 is your perfect companion. Installed with a fast quad-core processor, IM508 offers maximum convenience and swift diagnosis. The intuitive user screen makes using the device effortless through a 7-inch LCD touchscreen that displays at 1024 x 600 quality. Together with the ability to quickly read and clear DTCs for all available modules of the majority of the makes and models on the market, IM508 provides you with superior special functions, including Oil Reset, EPB (Electronic Parking Brake), SAS (Steering Angle Sensor), BMS (Battery Management System), DPF (Diesel Particulate Filter), IMMO, and TPMS (Tire Pressure Monitoring System). What is more, together with the key programmer XP200, IM508 is capable of providing extraordinary service functions for the immobilizer system.

This manual describes the construction and operation of the device and how it works to deliver diagnostic solutions.

MaxiIM IM508 Tablet

Function Description

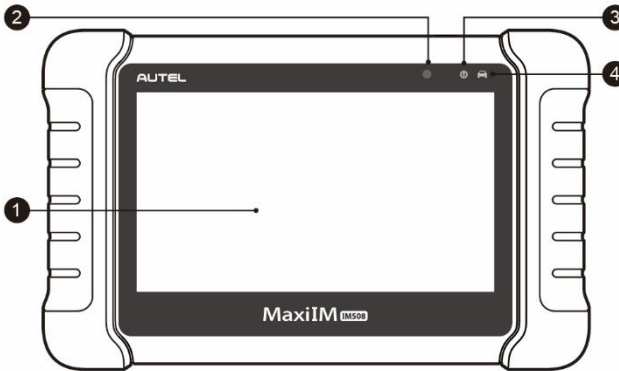

Figure 2-1 MaxiIM IM508, Front View

1. 7.0" LCD Capacitive Touchscreen
2. Ambient Light Sensor — detects ambient brightness.
3. Power LED — indicates battery level & charging or system status.
4. Vehicle Communication LED — flashes green when the Display Tablet is communicating/linking with the vehicle's system.

The power LED displays green, yellow or red depending on power level and operating state.

- A. Green
 - Illuminates green when the Display Tablet is charging and the battery level is above 90%.
 - Illuminates green when the Display Tablet is powered on and the battery level is above 15%.
- B. Yellow
 - Illuminates yellow when the Display Tablet is charging and the battery level is below 90%.
- C. Red
 - Illuminates red when the Display Tablet is powered on and the battery level is below 15%.

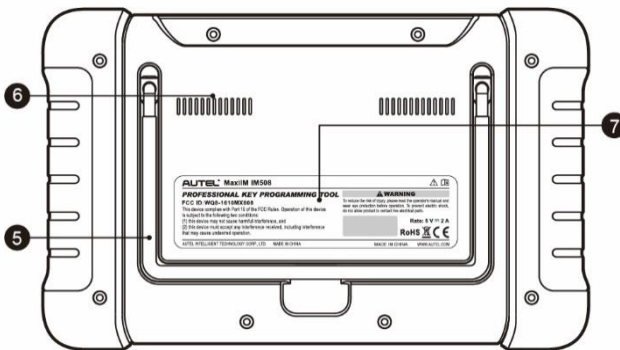

Figure 2-2 MaxilM IM508, Back View

- 5. Collapsible Stand — extends from the back to allow hands-free viewing of the Display Tablet.
- 6. Heat Sink
- 7. Built-in Battery

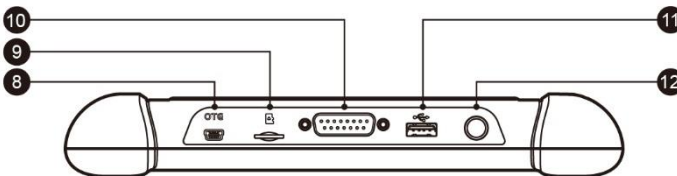

Figure 2-3 MaxilM IM508, Top View

- 8. Mini USB OTG Port
- 9. Micro SD Card Slot — holds the micro SD card.
- 10. DB15-Pin Port — connects the main cable.
- 11. USB Port
- 12. Lock/Power Button — turns the device on & off with long press, or locks the screen

with short press.

Power Sources

The tablet can receive power from any of the following sources:

- Internal Battery Pack
- External Power Supply

Internal Battery Pack

The tablet can be powered with the internal rechargeable battery, which if fully charged can provide sufficient power for about 4.5 hours of continuous operation.

Vehicle Power

When the tablet is connected to the test vehicle via the main cable, the tablet automatically receives power from the vehicle.

External Power Supply

The tablet can be powered from a wall socket using the mini USB cable and USB external power adapter. The external power supply also charges the internal battery pack.

Technical Specifications

Table 2-1 Specifications

| Item | Description |
|-------------------------|---|
| Recommended Use | Indoor |
| Operating System | Android™ 4.4.4 |
| Processor | Cortex-A9 processor (1.6 GHz) |
| Memory | 32 GB |
| Display | 7-inch LCD capacitive touchscreen with 1024x600 resolution |
| Connectivity | <ul style="list-style-type: none">● Mini USB 2.0● USB 2.0● Wi-Fi● Micro SD card (supports up to 32 GB) |
| Sensors | Ambient light sensor for brightness auto changing |

| Item | Description |
|---------------------------------------|---|
| Audio Output | Buzzer |
| Power and Battery | <ul style="list-style-type: none"> ● 3.7 V/5000 mAh lithium-polymer battery ● Charges via 5 V DC power supply |
| Tested Battery Life | Around 4.5 hours of continuous use |
| Battery Charging Input | 5 V/1.5 A |
| Power Consumption | 500 mA (LCD on with default brightness, Wi-Fi on) @3.7 V |
| Operating Temp. | 0 to 50 °C (32 to 122 °F) |
| Storage Temp. | -20 to 60 °C (-4 to 140 °F) |
| Operating Humidity | 5 to 95 % non-condensing |
| Dimensions (W x H x D) | 237.8 mm (9.4") x 148.6 mm (5.9") x 35.5 mm (1.4") |
| Net Weight | 788 g (2.42 lbs.) |
| Supported Automotive Protocols | ISO9141-2, ISO14230-2, ISO15765, K/L-Line, Flashing Code, SAE-J1850 VPW, SAE-J1850 PWM, ISO11898(Highspeed, Middlespeed, Lowspeed and Singlewire CAN, fault-tolerant CAN), SAE J2610, GM UART, UART Echo Byte Protocol, Honda Diag-H Protocol, TP2.0, TP1.6 |

Accessory Kit

Main Cable

The Main Cable connects the tablet to the vehicle's data link connector (DLC).

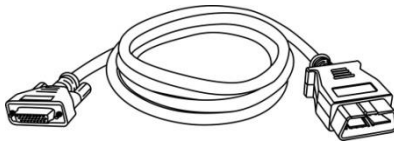

Figure 2-4 Main Cable

Other Accessories



Mini USB Cable

Connects the tablet to the PC or DC external power adapter.

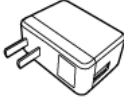

USB External Power Adapter

Together with the mini USB cable, connects the tablet to the external DC power port for power supply.



Quick Guide

Device connection and diagnostic software update instructions.

XP200

The XP200 is specially designed to read vehicle key chip data, clone and generate exclusive keys, read/write on-board EEPROM data, and read/write Freescale 9S12 MCUs. By working with diagnostic tool and PC that are both loaded with programmer software, the XP200 can read/write key chip data quickly and accurately.

Specifications

Table 2-2 Specifications

| Item | Description |
|----------------------------|----------------------------|
| Operating Temperature | -10 to 50 °C (14 to 122°F) |
| Storage Temperature | -20 to 60 °C (-4 to 140°F) |
| Port | Mini USB, VGA_DB15 |
| Input Voltage | 5 V DC |
| Operating Current | < 250 mA |
| Maximum Consumption | 1 W |
| Device Dimensions (L*W*H) | 130 mm x 68 mm x 28 mm |
| Package Dimensions (L*W*H) | 201 mm x 167 mm x 75 mm |
| Net Weight | 466 g |

Accessories Included



APB001 — EEPROM Adaptor

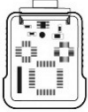

APB002 — 68HC908 Adaptor

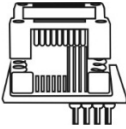

APA002 — EEPROM Socket

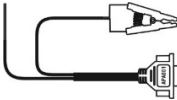

APA001 — EEPROM Clamp Integrated MC9S12 Cable

Components and Ports

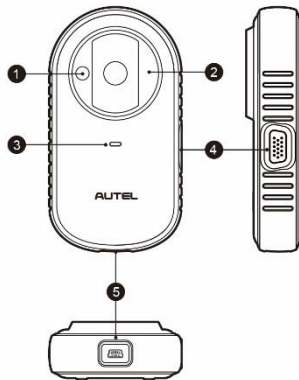

Figure 2-4 XP200 Views

1. Vehicle Key Chip Slot — holds the vehicle key chip.
2. Vehicle Key Slot — holds the vehicle key.
3. Status LED Light — indicates the current operating status.
4. Connection Port — connects EEPROM Adaptor and EEPROM Clamp Integrated MC9S12 Cable.
5. USB Port — provides data communication and power supply.

Vehicle Key Slot

Holds the Vehicle Key to read and write vehicle key information.

Vehicle Key Chip Slot

Holds the Vehicle Key Chip to read and write vehicle key chip information.

Status LED Light

The status LED of the XP200 indicates the operating status of the device.

Table 2-3 Status LED Light on the Front Panel

| LED Light | Color/Status | Description |
|-----------|----------------|-------------------------------|
| Power | Solid Green | Powered on and Default Status |
| | Flashing Green | Communication Status |
| | Solid Red | Error Status |

Connection Port

There are two accessories that can be paired with the connection port: EEPROM Clamp Integrated MC9S12 Cable and EEPROM Adaptor.

EEPROM Clamp Integrated MC9S12 Cable

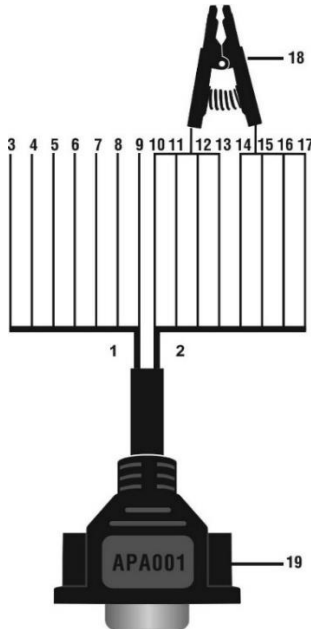

Figure 2-5 EEPROM Clamp Integrated MC9S12 Cable

1. MC9S12 Cable

Table 2-4 Definitions of MC9S12 Cable

| No. | Color | Definition | Pin correspond to DB15 | Note |
|-----|--------|------------|------------------------|---------------|
| 3 | Green | TXCLKS | 1 | |
| 4 | Black | GND | 2 | Shielded line |
| 5 | White | TOSC | 6 | Shielded line |
| 6 | Blue | TSW | 7 | |
| 7 | Brown | GND | 8 | |
| 8 | Yellow | TRESET | 11 | |
| 9 | Red | VDD | 12 | |

2. EEPROM Clamp Cable

Table 2-5 Definitions of EEPROM Clamp Cable

| No. | Color | Definition | Pin correspond to DB15 | Note |
|-----|--------------|------------|------------------------|----------------|
| 10 | Orange | P1 | 5 | Pin 1 is red |
| 11 | Light Grey | P2 | 15 | |
| 12 | Purple | P3 | 10 | |
| 13 | Grey | P4 | 4 | |
| 14 | Light Blue | P5 | 14 | |
| 15 | Pink | P6 | 9 | |
| 16 | Light Green | P7 | 3 | |
| 17 | Light Purple | P8 | 13 | Pin 8 is black |

Here are the possible causes for EEPROM read/write failure and data error when connecting the clamp to the test board for EEPROM read/write:

- A. EEPROM read/write operations are affected by the circuit of the connected test board;
- B. EEPROM read/write operations of the test board are affected by the read/write operations of the clamp;
- C. The signal is damaged by large resistance. A large resistance will be generated when connecting the clamp to a fast communicating EEPROM or using a long cable

for connection.

Therefore, it is recommended to dismantle the chip on the EEPROM, weld the EEPROM to the EEPROM adaptor or place in the EEPROM socket, and then insert it in the EEPROM adaptor.

18. EEPROM Clamp

19. DB15 VGA Port

EEPROM Adaptor

The EEPROM adaptor is compatible with three 8-pin packaging TSSOP, SOP, DIP connections, and each packaging reserves three same ports, so the device will function properly when one port is damaged. For SOP8 packaging, the EEPROM adaptor can also work with the EEPROM socket. To do this, place the pins of the SOP8 EEPROM into the EEPROM accordingly and then insert them into the EEPROM adaptor.

USB Port

The USB port is used for the data communication between the XP200 and the diagnostic device or the PC, and it is also the port for power supply charge.

3. Getting Started

Ensure the tablet is sufficiently charged or is connected to the external power supply (see [Power Sources](#)).

NOTE

The images and illustrations depicted in this manual may differ from the actual ones.

Powering Up

Long press the **Lock/Power** button on the top right of the tablet to power on the unit. The power LED light will illuminate green. The system boots up, and displays the lock screen. Slide the Lock icon to the left to enter the MaxiIM Job Menu or slide to the right to unlock.



Figure 3-1 Sample Job Menu

1. Application Buttons
2. Locator and Navigation Buttons
3. Status Icons

NOTE











The tablet screen is locked by default when first powered on. It is recommended to lock the screen to protect the information in the system and reduce the power consumption.



The touch screen navigation is menu driven enabling quick access to functions and features by tapping on options headings and answering dialog windows. Detailed descriptions of the menu structures are found in the application chapters.

Application Buttons

Descriptions of the tool applications are displayed in the table below.

Table 3-1 Applications











| Button | Name | Description |
|---|------------------------|--|
|  | IMMO | Accesses IMMO functions menu. See IMMO . |
|  | Programming | Accesses Programming functions menu. See Programming . |
|  | Diagnostics | Accesses diagnostic functions menu. See Diagnostics . |
|  | Service | Accesses special functions menu. See Service . |
|  | Update | Checks for the latest update available for the MaxiIM system, and performs updates. See Update . |
|  | Settings | Accesses MaxiIM system settings menu and general tablet menu. See Settings . |
|  | Remote Desk | Configures the unit to receive remote support using the TeamViewer application program. See Remote Desk . |
|  | Data Manager | Accesses the organization system for saved data files. See Data Manager . |
|  | Shop Manager | Accesses the Shop Manager program. See Shop Manager . |
|  | Function Viewer | Provides quick search for the supported functions and vehicles of Autel diagnostics tools. See Function Viewer . |

| Button | Name | Description |
|---|-------------------|---|
|  | Support | Launches the Support platform which synchronizes Autel's on-line service base station with the MaxiIM tablet. See Support . |
|  | Academy | Accesses technical tutorials and training articles about the device usage and vehicle diagnostics techniques. See Academy . |
|  | Quick Link | Provides associated website bookmarks to allow quick access to product update, service, support and other information. See Quick Link . |

Locator and Navigation Buttons

Operations of the Navigation buttons at the bottom of the screen are described in the table below:

Table 3-2 Locator and Navigation Buttons

| Button | Name | Description |
|---|----------------------------|--|
|  | Locator | Indicates the location of the screen. Swipe the screen left or right to view the previous or next screen. |
|  | Back | Returns to the previous screen. |
|  | Android Home | Returns to Android System's Home screen. |
|  | Recent Apps | Displays a list of applications that are currently in use. Tap an app icon to launch. To remove an app, swipe it to the top or bottom. |
|  | Chrome | Launches the Android built-in browser. |
|  | Screenshot | Takes a screenshot when you want to save the displayed information. |
|  | MaxiIM Home | Returns to MaxiIM Job Menu. |
|  | IMMO Shortcut | Returns to the IMMO screen. |
|  | Diagnostic Shortcut | Returns to the Diagnostic screen. |
|  | Service Shortcut | Returns to the Service screen. |

System Status Icons





As the tablet is working with the Android operating system, you may refer to Android documents for more information.

By up sliding the bottom right corner, a Shortcuts Panel will be displayed, on which you are allowed to set various system settings of the tablet. Operations of each button on the panel are described in the table below:

NOTE

The shortcuts buttons will be highlighted when enabled and dimmed when disabled.

Table 3-3 Shortcuts Panel Buttons

| Button | Name | Description |
|---|------------------------|---|
|  | Calculator | Launches calculator when pressed. |
|  | Clock | Launches clock when pressed. |
|  | Wi-Fi | Enables/disables Wi-Fi when pressed. |
|  | Airplane Mode | Enables/disables Airplane Mode when pressed. |
|  | System Settings | Launches the Android System Settings screen when pressed. |

Powering Down

All vehicle communications must be terminated before shutting down the tablet. A warning message displays if you attempt to shut down the tablet when it is communicating with the vehicle. Forcing a shut-down while communicating may lead to ECM problems on some vehicles. Please exit the Diagnostics application before powering down.

➤ To power down the tablet

1. Long press the **Lock/Power** Button.
2. Tap **Power off** option.
3. Tap **OK**, the tablet will turn off in a few seconds.

Reboot System

In case of system crash, long press the **Lock/Power** button and tap **Reboot** option to reboot the system.

4. IMMO

The IMMO application provides Smart Mode and Expert Mode to guide technicians performing IMMO related functions, including Key Learning, Remote Control Learning, Remote Control Add, etc.

Getting Started

Ensure a communication link is established between the test vehicle and the tablet via the main cable, and the XP200 is connected to the tablet with the supplied USB cable.

Vehicle Menu Layout

When the tablet is properly connected to the vehicle, the platform is ready to start vehicle diagnosis. Tap on the **IMMO** application button on the MaxiIM IM508 Job Menu to access the Vehicle Menu.













Figure 4-1 Sample Vehicle Menu

1. Top Toolbar Buttons
2. Manufacturer Buttons

Top Toolbar Buttons

The operations of the toolbar buttons at the top of the screen are listed and described in the table below:

Table 4-1 Top Toolbar Buttons

| Button | Name | Description |
|--|-----------------|---|
|  | Home | Returns to the MaxiIM Job Menu. |
|  | VIN Scan | Displays a dropdown list; tap Auto Detect for auto VIN detection; tap Manual Input to enter VIN manually. |
|  | All | Displays all the vehicle makes in the vehicle menu. |
|  | History | Displays the stored test vehicle history records. This option provides you direct access to the previously tested vehicle recorded during previous test sessions. See Vehicle History . |
|  | USA | Displays the USA vehicle menu. |
|  | European | Displays the European vehicle menu. |
|  | Asia | Displays the Asian vehicle menu. |
|  | China | Displays the Chinese vehicle menu. |
|  | Search | Displays the virtual keyboard to manually enter the specific vehicle make required. |
|  | Cancel | Exits the search screen or cancel an operation. |

Manufacturer Buttons

To begin, select the manufacturer button of the test vehicle, followed by the vehicle model and year.

Vehicle Identification

The MaxiIM diagnostic system supports four methods for Vehicle Identification.

1. Auto VIN Scan
2. Manual VIN Input
3. Automatic Selection
4. Manual Selection

Auto VIN Scan and Manual VIN Input functions are applicable for IMMO, Diagnostic and Service applications, Automatic Selection and Manual Selection are applicable for Diagnostic and Service applications. In IMMO, except Auto VIN Scan and Manual VIN Input methods, technicians can also manually select vehicle manufacturer, instrument information step by step to locate the desired IMMO part, but it is a little different from Automatic Selection and Manual Selection. Besides, as Programming does not require connection with the vehicle, therefore, Auto VIN Scan is not applicable for this application, and technicians can manually select the part information follow the onscreen instructions to display the function menu.

Auto VIN Scan

The MaxiIM diagnostic system features the latest VIN-based Auto VIN Scan function to identify vehicles and it is applied to IMMO, Programming, Diagnostic and Service applications. IMMO provides two modes: Smart Mode and Expert Mode, and only Smart Mode can be accessed by using Auto VIN function.

➤ To perform Auto VIN Scan

1. Tap the **IMMO** application button from the MaxiIM Job Menu. The Vehicle Menu displays.
2. Tap the **VIN Scan** button on the top toolbar to open a dropdown list.



Figure 4-2 Sample Auto VIN Screen

3. Select **Auto Detect**. Once the test vehicle is successfully identified, the screen will display the vehicle profile. Tap **OK** at the bottom right to confirm the vehicle profile. If the VIN does not match with the test vehicle's VIN, enter VIN manually or tap **Read** to acquire VIN again.
4. Tap **Yes** to confirm the vehicle profile or **No** if the information is not correct.
5. The tool establishes communication with the vehicle and reads the IMMO control unit information.

Manual VIN Input

For vehicles that not supporting the Auto VIN Scan function, you may manually enter the vehicle VIN.

➤ **To perform Manual VIN Input**

1. Tap the **IMMO** application button from the MaxiIM Job Menu. The Vehicle Menu displays.
2. Tap the **VIN Scan** button on the top toolbar.
3. Select **Manual Input**.

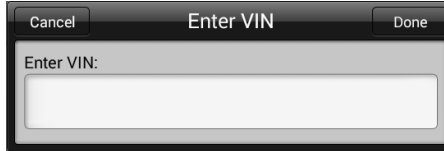

Figure 4-3 Sample Enter VIN Screen

4. Tap the input box and enter the correct VIN.
5. Tap **Done** to complete or tap **Cancel** to exit Manual Input.

Automatic Selection

The Automatic Selection can be selected after selecting the test vehicle manufacturer.

➤ **To perform Automatic Selection**

1. Tap the **Diagnostic** application button from the MaxiIM Job Menu. The Vehicle Menu displays.
2. Tap the manufacturer button of the test vehicle.
3. Tap **Automatic Selection** and the VIN information will be automatically acquired. Follow the on-screen instruction to display the function screen.

Manual Selection

When the vehicle's VIN is not automatically retrievable through the vehicle's ECU, or the specific VIN is unknown, the vehicle can be manually selected.

This mode of vehicle selection is menu driven, repeat the first two steps from the automatic selection operation and tap **Manual Selection**. Through a series of on-screen prompts and selections, the test vehicle is chosen. If needed, press the **Back** button at the bottom right corner of the screen to return to the previous screen.

Navigation

Navigating the IMMO interface and selecting test are discussed in this section.

IMMO Screen Layout



Figure 4-4 Sample Mode Selection Screen





The IMMO screens typically include four sections.



1. Operation Toolbar
2. Status Information Bar
3. Main Section
4. Function Buttons

Operation Toolbar

The Operation Toolbar contains a number of buttons such as print and save. The table below provides a brief description of the operations.

Table 4-2 Operation Toolbar Buttons

| Button | Name | Description |
|---|---------------------|---|
|  | Home | Return to the MaxiIM Job Menu. |
|  | Vehicle Swap | Exit the function session of the currently identified test vehicle and return to the vehicle menu screen. |
|  | Settings | Open the settings screen. See Settings . |
|  | Print | Print a copy of the displayed data. See Printing Setting for additional information. |
|  | Help | Display operational instructions or tips. |

| Button | Name | Description |
|---|---------------------|--|
|  | Save | Tap to open a sub menu, tap Take a Screenshot to save the current screen. All saved data is stored in the Data Manager application for later reviews. See Data Manager . |
|  | Data Logging | Record the communication data and ECU information of the test vehicle. The saved data can be reported and sent to the technical center via the Internet. You can go to the Support application to follow up the processing progress, see Data Logging for detailed information. |

➤ **To print data**

1. Tap the **IMMO** application button from the MaxiIM Job Menu. The **Print** button on the toolbar is available throughout the IMMO operations.
2. Tap **Print**. A drop-down menu displays. Tap **Print This Page** to print a screenshot of the current screen.
3. A temporary file will be created and send to the connected PC for printing.
4. When the file is transferred successfully, a confirmation message displays.

➤ **To submit Data Logging reports**

1. Tap the **IMMO** application button from the MaxiIM Job Menu. The **Data Logging** button on the toolbar is available throughout the IMMO operations.
2. Tap the **Data Logging** button. The button displays blue during the active recording process.
3. Tap the **Data Logging** button again to end recording. A submission form will display for inputting of report information.
4. Tap the **Send** button to submit the report form via the Internet. A confirmation message displays when the report has been successfully sent.

Status Information Bar

The Status Information Bar at the top of the Main Section displays the following items:

1. Menu Title — displays the menu heading of the Main Section.
2. Voltage Icon — displays the vehicle's voltage status.

Main Section

The Main Section of the screen varies depending on the stage of operations. The Main Section can display vehicle identification selections, the main menu, test data, messages,

instructions and other information. In this case, it shows the two modes IMMO provides: Smart Mode and Expert Mode.

Function Buttons

The displayed Function Buttons vary depending on the stage of operations. Function buttons can be used to navigate menus, to save or clear data, to exit scanning and to perform a number of other control functions. The use of these buttons will be discussed in detail in the following sections of the corresponding test operations.

Screen Messages

Screen messages appear when additional input is needed before proceeding. There are three main types of on-screen messages: Confirmation, Warning, and Error.

Confirmation Messages

This type of messages usually displays as an “Information” screen to inform the user that a selected action cannot be reversed or when an action has been initiated and confirmation is needed to continue.

When a user-response is not required to continue, the message displays briefly.

Warning Messages

This type of messages displays a warning that a selected action may result in an irreversible change or loss of data. An example of this type of message is the “Erase Codes” message.

Error Messages

Error messages display when a system or procedural error has occurred. Examples of possible errors include a disconnection or communication interruption.

Making Selections

The IMMO application is a menu driven program that presents a series of choices. As a selection is made, the next menu in the series displays. Each selection narrows the focus and leads to the desired test. Tap the screen to make menu selections.

IMMO

The IMMO application requires a data link to the IMMO electronic control system of the test vehicle for diagnosis via OBDII connection. The application retrieves vehicle IMMO information and performs IMMO related functions, including Key Learning, Remote Control Learning, Remote Control Add, etc.

There are two options available when accessing the IMMO section:

1. Smart Mode — accesses to a function menu where each function is configured as a smart guide system.
2. Expert Mode — accesses to a function menu where each function is separated from each other.

After a mode is selected and the tablet establishes communication with the vehicle, the corresponding function menu or selection menu displays.

Smart Mode

The Smart Mode provides guided functions with step-by-step instructions. Once the test vehicle is identified, a vehicle profile will display, select **Yes** to continue.



Figure 4-5 Sample Vehicle Information Screen

The tablet will access the vehicle IMMO ECU to read IMMO related information. Press **OK** to continue. Then the vehicle key status will display.

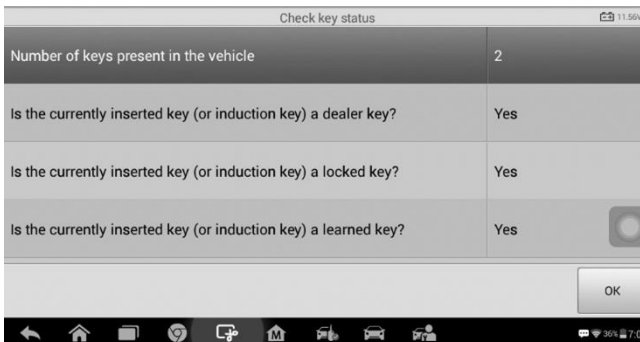

Figure 4-6 Sample Check Key Status Screen

Read the vehicle key status carefully and press **OK** to display the function menu.

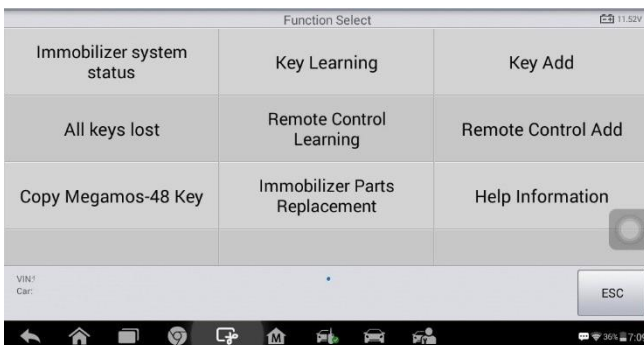

Figure 4-7 Sample Function Menu in Smart Mode

The functions vary by IMMO parts, please follow the on-screen instructions to select the correct IMMO part.

Take **Key Learning** as an example.

1. Select **Key Learning** from the function menu. The tablet will automatically start to read IMMO data.

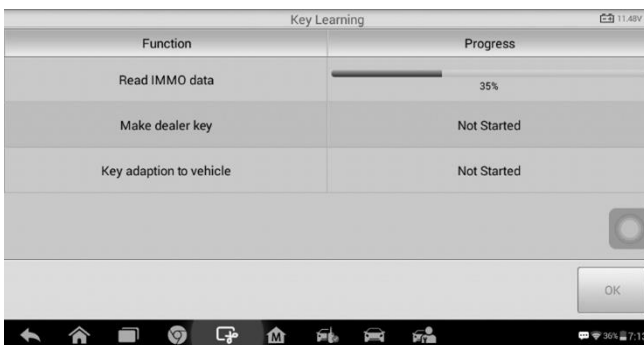

Figure 4-8 Sample Key Learning Screen 1

2. When Read IMMO data completes, the tablet will prompt a “Do you need to make dealer key?” message, select **Yes** to confirm, or select **No** to quit the operation.



Figure 4-9 Sample Key Learning Screen 2

3. Follow the on-screen instruction to place a Blank Key in the XP200 keyhole and press **OK** to continue.



Figure 4-10 Sample Key Learning Screen 3

4. If the new key is blocked, the tablet will ask if you want to unlock the key, select **Yes** to continue, or select **No** to quit the operation.
5. A "Make dealer key success!" message displays when the process is completed successfully.
6. Then the tablet will automatically move to the next step, Key adaption to vehicle, and the following message will prompt up.

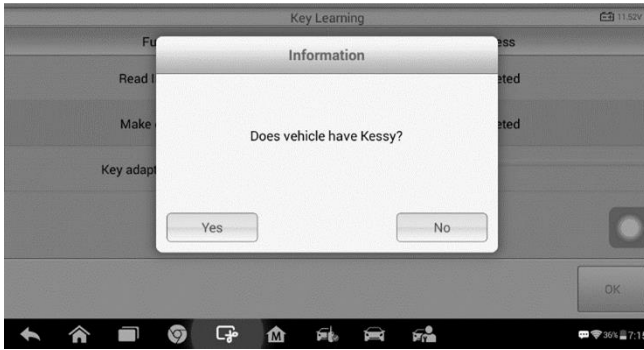

Figure 4-11 Sample Key Learning Screen 4

7. Make selections according to the test vehicle.
8. Input the numbers of the keys to be learned and press **OK** to continue.

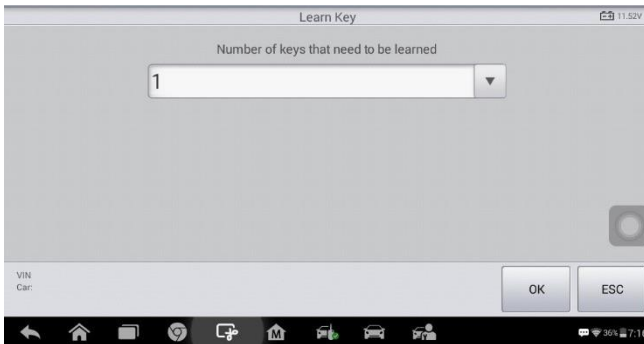

Figure 4-12 Sample Key Learning Screen 5

9. Follow the on-screen instructions to insert the key to be learned into the vehicle ignition switch.

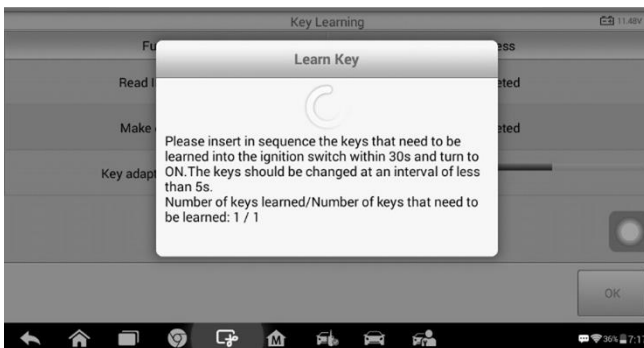

Figure 4-13 Sample Key Learning Screen 6

10. When Key Learning is completed successfully, the following screen displays. Press

OK to exit the function.

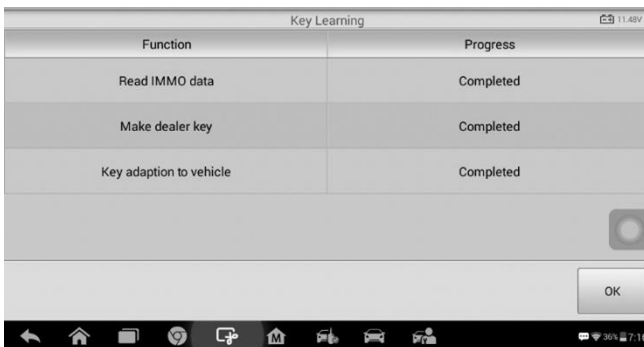

Figure 4-14 Sample Key Learning Screen 7

Expert Mode

Expert Mode provides skilled technicians a convenient way to perform individual IMMO functions they need. All the function options in this mode are separated segments. If needed, technicians can only perform one segment function instead of a whole process provided in Smart Mode.

1. Select vehicle manufacturer in the vehicle menu, and then select the IMMO part information step by step to locate the IMMO part and display the function menu.

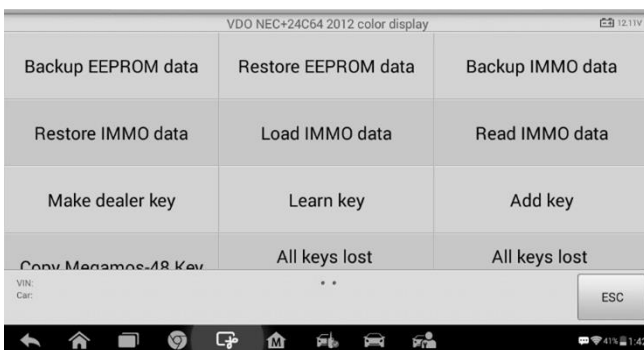

Figure 4-15 Sample Expert Mode Function Menu

Take **Read IMMO Data** as an example.

Select **Read IMMO Data** from the function menu. The tablet will start to read IMMO information. Review the data and press **OK** to exit.

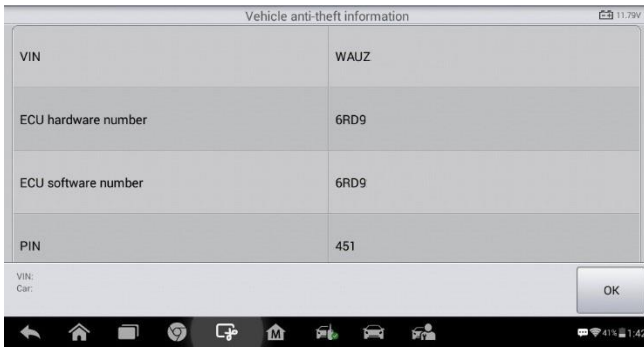

Figure 4-16 Sample Read IMMO Data Screen

After read the IMMO data, technicians can perform other IMMO functions with the read data in Expert Mode.

5. Programming

The Programming application requires connection between the tablet and the XP200, and no vehicle connection is required. This application can access the key chip, read, retrieve and write key information, as well as other key related functions.

Programming

Select the vehicle manufacturer in the vehicle menu, and then follow the onscreen instructions to select the instrument information to display the function menu.

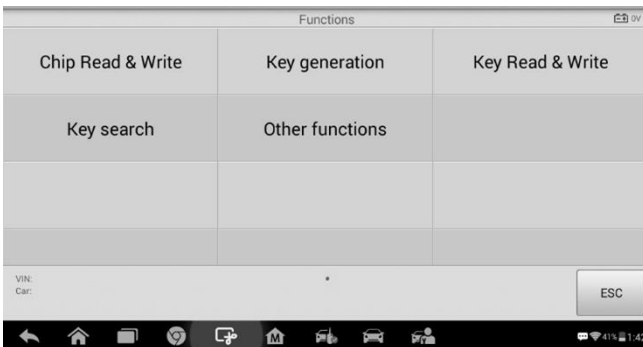

Figure 5-1 Sample Programming Function Menu

Take **Chip Read & Write** as an example.

1. Select **Chip Read & Write** from the menu.
2. Select the chip type if needed. In this example, select **EEPROM**.



Figure 5-2 Sample Select Chip Type Screen

3. Select **Read Operation** on the next menu.

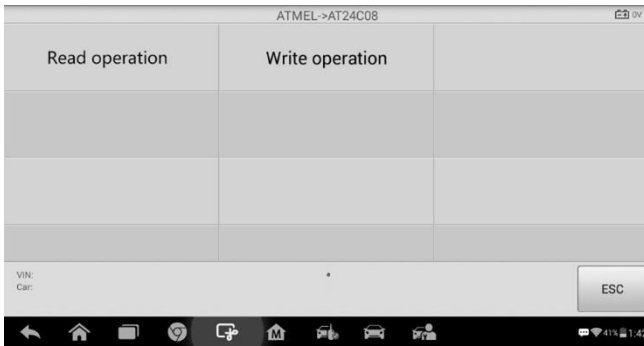

Figure 5-3 Sample Operations Menu

4. The chip data screen displays. Select **Save** to save the data, or select **Cancel** to exit.



Figure 5-4 Sample Read Operation Screen

5. Type the file name and select Confirm, the chip data will be saved on the tablet. And a “File saved successfully.” Message displays.



Figure 5-5 Sample Save Data Screen

6. Select **Write Operation** from the operations menu. The tablet will open the default folder, select the saved data and click **Confirm** to write it into a black chip.

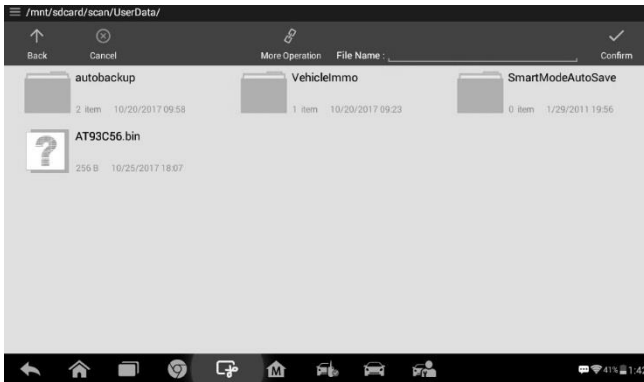

Figure 5-6 Sample Write Operation Screen

6. Diagnostics

The Diagnostics application can retrieve ECU information, read & erase DTCs, and view live data. The Diagnostics application can access the electronic control unit (ECU) for various vehicle control systems, including engine, transmission, antilock brake system (ABS), airbag system (SRS).

Diagnosis

The Diagnostics application enables a data link to the electronic control system of the test vehicle for vehicle diagnosis via OBDII connection. The application performs functional tests, retrieves vehicle diagnostic information such as trouble and event codes and live data for various vehicle control systems, such as engine, transmission, and ABS.

There are two options available when accessing the Diagnosis section:

1. Auto Scan — starts auto scanning for all the available systems on the vehicle.
2. Control Unit — displays a selection menu of all available control units of the test vehicle.

After a section is made and the tablet establishes communication with the vehicle, the corresponding function menu or selection menu displays.

Auto Scan

The Auto Scan function performs a comprehensive scanning over all the ECUs in the vehicle to locate systems' faults and retrieve DTCs. An example of the Auto Scan interface is pictured below:

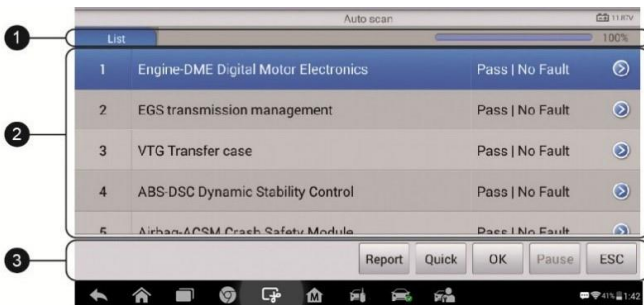

Figure 6-1 Sample Auto Scan Operation Screen

1. Navigation Bar
2. Main Section

3. Function Buttons

Navigation Bar

List Tab — displays the scanned data in list format.

Progress Bar — indicates the test progress.

Main Section

Column 1 — displays the sequence numbers.

Column 2 — displays the scanned systems.

Column 3 — displays the diagnostic indicators describing test results.

These indicators are defined as follows:

- ❖ **-!-**: Indicates that the scanned system may not support the code reading function, or there is a communication error between the tablet and the control system.
- ❖ **-?-:** Indicates that the vehicle control system has been detected, but the tablet cannot accurately locate it.
- ❖ **Fault(s) | #:** Fault(s) indicates there is/are detected fault code(s) present; “#” indicates the number of the detected faults.
- ❖ **Pass | No Fault:** Indicates the system has passed the scanning process and no fault has been detected.

Column 4 — to perform further diagnosis or testing on a specific system item, tap the button  to the right of that item. A Function Menu screen will display.

Function Buttons

A brief description of the operations of the Auto Scan's Function Buttons' are displayed in the table below.

Table 6-1 Function Buttons in Auto Scan

| Name | Description |
|---------------|--|
| Report | Display the diagnostic data in the report form. |
| Quick | Delete codes. A warning message screen will display to inform you of possible data loss when this function is selected. |
| OK | Confirm the test result. Continue to the system diagnosis after the required system is selected by tapping the item in the Main Section. |
| Pause | Suspend scanning and it will change to Continue button after tapping. |
| ESC | Return to the previous screen or exits Auto Scan. |

Control Unit

Manually locate a required control system for testing through a series of selection choices. Follow the menu driven procedures and make proper selection; the application guides the user to the proper diagnostic function menu based on selections.

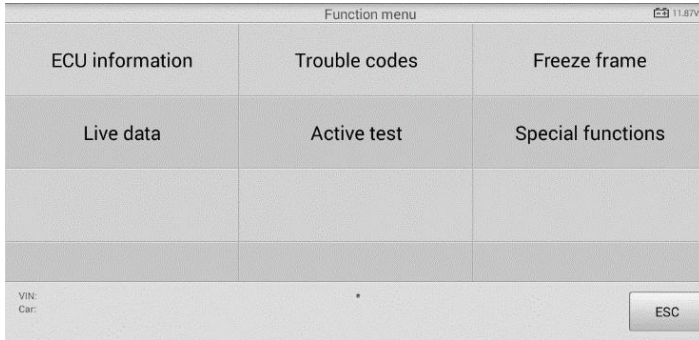

Figure 6-2 Sample Function Menu

The Function Menu options vary slightly for different vehicles. The function menu may include:

- **ECU Information** — provides the retrieved ECU information in detail. An information screen opens upon selection.
- **Trouble Codes** — includes **Read codes** and **Erase codes** functions. Displays detailed information of DTC records retrieved from the test vehicle's ECU and erases DTC records and other data from the test vehicle's ECU.
- **Freeze Frame** — displays the freeze frame data of the DTCs.
- **Live Data** — retrieves and displays live data and parameters from the test vehicle's ECU.
- **Active Test** — accesses vehicle-specific subsystem and components test.
- **Special Function** — performs various component adaptations.

NOTE

Toolbar functions such as saving and printing of test results can be performed throughout diagnostic testing. Data logging and access to help information are also available.

➤ To perform a diagnostic function

1. Establish communication with the test vehicle.
2. Identify the test vehicle by selecting from the menu options.
3. Select the **Diagnosis** section.
4. Locate the required system for testing by **Auto Scan** or through menu driven selections in **Control Unit**.
5. Select the desired diagnostic function from the **Function Menu**.

ECU Information

This function retrieves and displays the specific information for the tested control unit, including unit type, version numbers and other specifications.

The sample ECU Information screen displays as below:

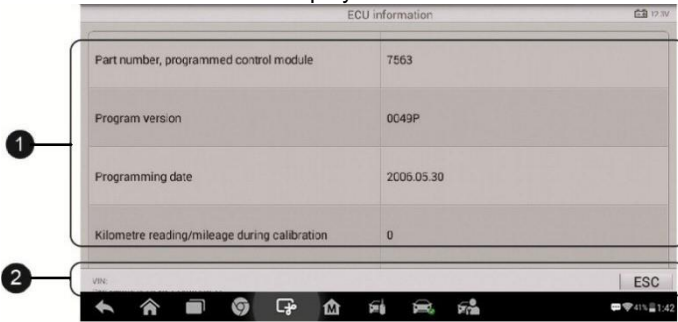

Figure 6-3 Sample ECU Information Screen

1. Main Section — the left column displays the item names; the right column displays the specifications or descriptions.
2. Function Button — **ESC** (or **Back**) button is available; tap it to exit after viewing.

Trouble Codes

Read Codes

This function retrieves and displays the DTCs from the vehicle's control system. The Read Codes screen varies for each vehicle being tested. On some vehicles, freeze frame data can also be retrieved for viewing. The sample Read Codes screen displays as below:

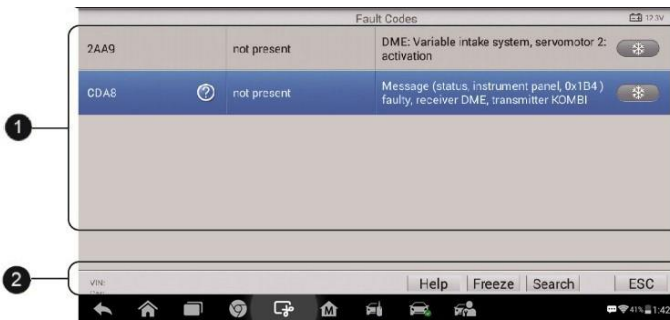

Figure 6-4 Sample Read Codes Screen

1. Main Section
 - Code Column — displays the retrieved codes from the vehicle.
 - Status Column — indicates the status of the retrieved codes.
 - Description Column — detailed descriptions for the retrieved codes.
 - Snowflake Icon — only displays when freeze frame data is available for viewing; selecting this icon will display a data screen, which looks and behaves similar to the Read Codes screen.
2. Function Button
 - Help — tap it to view fault code information, including fault description, condition for fault identification, and driver information.
 - Freeze — tap it to view the freeze frame data of the selected DTC.
 - Search — tap it to search related fault code information on Google.
 - ESC — tap it to return to the previous screen or exit the function.

Erase Codes

After reading the retrieved codes and making appropriate vehicle repairs, use this function to erase vehicle codes.

➤ **To erase codes**

1. Tap **Trouble Codes** from the Function Menu, then tap **Erase Codes**.
2. A warning message displays to advice of data loss if this function is completed.
 - a) Tap **Yes** to continue. A confirming screen displays when the operation is successfully done.
 - b) Tap **No** to exit.
3. Tap **ESC** on the confirming screen to exit Erase Codes.
4. Perform the Read Codes function again to check if codes have been erased successfully.

Live Data

When this function is selected, the screen displays the data list for the selected module. The data available for any control module varies from one vehicle to another. The parameters display in the order that they are transmitted by the ECM, so expect variation among vehicles.

Gesture scrolling allows for quick movement through the data list. Touch the screen and drag your finger up or down to reposition the parameters being displayed if the data populates more than one screen. The figure below displays a typical Live Data screen.

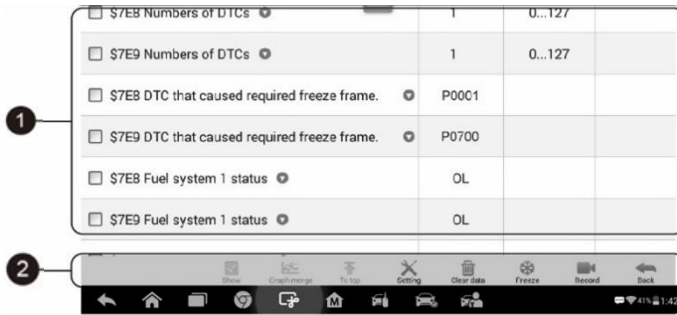

Figure 6-5 Sample Live Data Screen

1. Main Section

- Name Column — displays the parameter names.
 - a) Check Box — tap the check box on the left side of the parameter name to make item selection. Tap the check box again to deselect the item.
 - b) Drop-down Button — tap the drop-down button at the right side of the parameter name to open a sub menu, which provides optional modes by which to display the data.
- Value Column — displays the values of the parameter items.
- Unit Column — displays the unit for the parameters.
 - To change the unit mode, tap the **Setting** button on the top toolbar and select a required mode. See [Unit](#) for more information.

Display Mode

There are four types of display modes available for data viewing. Select the proper mode for the diagnostic purpose.

Tap the drop-down button on the right side of the parameter name to open a sub menu. There are four buttons to configure the data display mode, and a Help button for access to additional information.

Each parameter item displays the selected mode independently.

- 1) Analog Gauge Mode — displays the parameters in form of an analog meter graph.
- 2) Text Mode — this is the default mode which displays the parameters in texts and shows in list format.

 **NOTE**

Status parameters, such as a switch reading, can primarily be viewed in text form such as ON, OFF, ACTIVE, and ABORT. Whereas, value parameters, such as a sensor reading, can be displayed in text mode and graph modes.

3) **Waveform Graph Mode** — displays the parameters in waveform graphs.

When this mode is selected, three control buttons display on the right side of the parameter item for manipulation of display status.

- **Text Button** — resumes Text Display Mode.
- **Scale Button** — changes the scale values that are displayed below the waveform graph. There are four scales available: x1, x2, x4 and x8.
- **Zoom-in Button** — tap once to display the selected data graph in full screen.
 - ✧ **Edit Button** — tap to open an edit window, on which you can set the waveform color and the line thickness displayed for the selected parameter item.
 - ✧ **Scale Button** — tap to change the scale values, which are displayed below the waveform graph. There are four scales available: x1, x2, x4 and x8.
 - ✧ **Zoom-out Button** — tap to exit full screen display.

4) **Digital Gauge Mode** — displays the parameters in form of a digital gauge graph.

Full Screen Display — this option is only available in the waveform graph mode, and primarily used in Graph Merge status for data comparison. Under this mode, there are three control buttons available on the top right side of the screen.

➤ **To edit the waveform color and line thickness in a data graph**

1. Select 1 to 3 parameter items to display in Waveform Graph mode.
2. Tap the **Zoom-in Button** on the right to display the data graph in full screen.
3. Select a parameter item on the left column.
4. Select a desired sample color from the middle column.
5. Select a desired sample line thickness from the right column.
6. Repeat steps 3-5 to edit the waveform for each parameter item.
7. Tap **Done** to save the setting and exit, or tap **Cancel** to exit without saving.

2. **Function Buttons**

The operations of available function buttons on the Live Data screen are described below:

Back — returns to previous screen or exits the function.

Record — starts recording the retrieved live data; the recorded data is then stored as a video clip in the Data Manager application for future reviews. This function can be triggered automatically at preset threshold value or values may be set manually.

The triggering mode and record duration can be configured in the Setting mode of Live Data.

Freeze — displays the retrieved data in freeze frame mode.

- Previous Frame — displays previous frame if the freeze frame data.
- Next Frame — advances to the next frame in the freeze frame data.

Clear Data — tap button to clear all previously retrieved parameter values at a particular cutting point.

To Top — moves a selected data item to the top of the list.

Graph Merge — tap button to merge selected data graphs (for Waveform Graph Mode only). This function is useful for comparisons between different parameters.

 **NOTE**

In this mode, Graph Merge can only display up to three parameter items.

- To cancel Graph Merge mode, tap the drop-down button on the right side of the parameter name, and select a data display mode.

Show — tap button to switch between the two options; one displays the selected parameter items, the other displays all the available items.

Setting — tap button to access setting screen to set the trigger mode, recording duration and threshold values for data recording, and define other control settings.

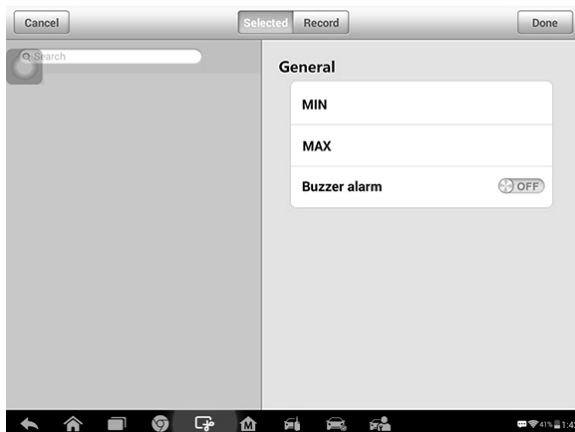

Figure 6-6 Sample Setting Mode in Live Data

There are four navigation buttons on top of the **Setting** mode screen.

- **Selected Button** — displays the configuration screen on which you can set the threshold values, an upper limit and a lower limit, for triggering the buzzer alarm. This function is only applied to the Waveform Graph display mode.
 - a) **MIN** — tap button to open a virtual keyboard, allowing you to enter the required lower limit value.

- b) **MAX** — tap button to open a virtual keyboard, allowing you to enter the required upper limit value.
- c) **Buzzer Alarm** — switches the alarm on and off.

➤ **To set threshold limits for the parameter values**



1. Tap the **Setting** function button at the bottom of the Live Data screen.
2. Tap the **Selected** navigation button.
3. Select a parameter item on the left column, or enter the item name in the Search bar.
4. Tap on the right side of the **MIN** button, and enter the required minimum value.
5. Tap on the right side of the **MAX** button, and enter the required maximum value.
6. Tap the **ON/OFF** button on the right side of the Buzzer Alarm button to turn it on or off.
7. Tap **Done** to save the setting and return to the Live Data screen; or tap **Cancel** to exit without saving.

If the threshold limits are successfully set, two horizontal lines will appear on each of the data graphs (when Waveform Graph Mode is applied) to indicate the alarming point. The threshold lines are shown in different colors from the waveform of the parameters for distinction.

- **Record Button** — displays the configuration screen for Record Setting, on which you can set the trigger type, duration and trigger point for the data recording function.

- a) **Trigger Type** — sets the trigger mode for data recording, mainly of two kinds: Manual and Auto. There are four options available:
 - 1) **Manual** — allows you to manually start and stop data recording
 - 2) **DTC** — auto triggers data recording when any DTC is detected
 - 3) **DTC Check Mode** — auto triggers data recording when certain pre-selected DTC types are detected
 - 4) **Parameter** — auto triggers data recording when any parameter value reaches the preset threshold
- b) **Duration** — sets the recording time (for Auto trigger mode only)
- c) **Trigger Point** — reserves a relative percentage of a record length before the data recording start point for reference (for Auto trigger mode only)

➤ **To perform setting for live data record**

1. Tap the **Setting** function button at the bottom of the Live Data screen.
2. Tap the **Record** navigation button.
3. Tap the  button on the right of **Trigger Type** bar and select the required trigger mode.
4. Tap the  button on the right of **Duration** bar and select a length of time.

5. Tap the  button on the right of **Trigger Point** bar and select a relative percentage of a record length to be reserved before the data recording start point.
6. Tap **Done** to save the setting and return to the Live Data screen; or tap **Cancel** to cancel without saving and exit Setting.
 - **Done Button** — confirms and saves the setting, and returns to the Live Data screen.
 - **Cancel Button** — cancels the setting operation, and returns to the Live Data screen.

Active Test

The Active Test function is used to access vehicle-specific subsystem and component tests. Available tests vary depending on the manufacturer, year, and model, and only the available tests display in the menu.

During an active test, the tablet sends commands to the ECU in order to drive the actuators. This test determines the integrity of the system or parts by reading the engine ECU data, or by monitoring the operation of the actuators, such as switching a solenoid, relay, or switch between two operating states.

Selecting **Active Test** opens a menu of test options that varies by make and model. Selecting a menu option activates the test. Follow on-screen instructions while performing tests. The content and pattern of the on-screen information vary according to the type of test being performed. Some toggle and variable control tests display Active Test Controls at the top of the screen with data stream information below, or vice versa.

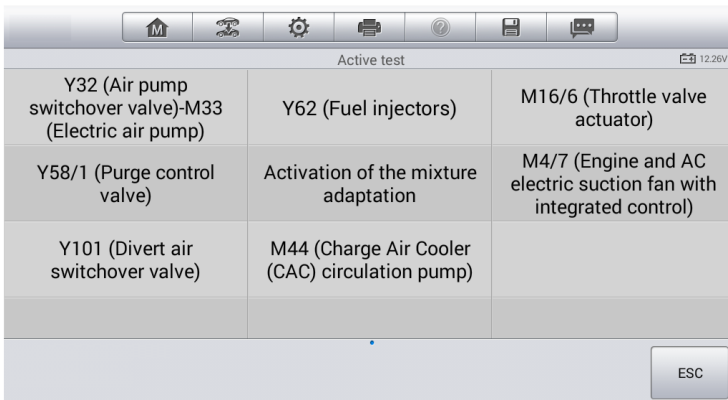

Figure 6-7 Sample Active Test Screen

The function buttons at the lower right corner of the Active Test screen manipulate the test signals. The operational instructions are displayed on the main section of the test screen. Simply follow the on-screen instructions and make appropriate selections to complete the tests. Each time when an operation is successfully executed, message such as “Command Finished”, “Activation Successful”, or something similar displays.

Tap the **ESC** function button to exit the test when finished.

Special Functions

These functions perform various component adaptations, allowing you to recalibrate or configure certain components after making repairs or replacement.

The main menu displays the supported special functions for the test vehicle. Follow the on-screen instructions to complete the desired function. When the operation is done, an execution status message such as Completed, Finished or Successful, displays. Tap the **ESC** button to exit the function.

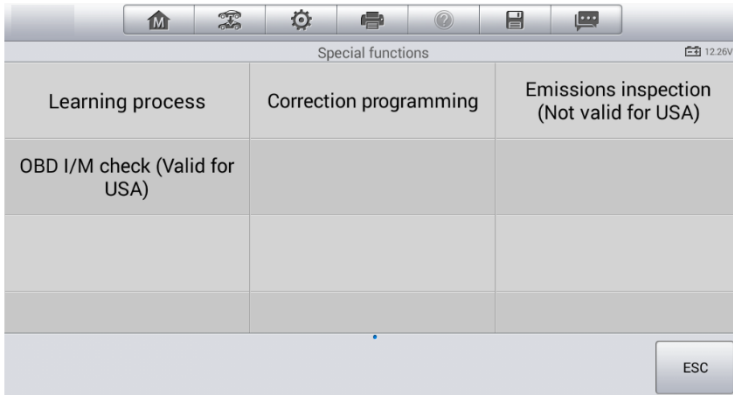

Figure 6-8 Sample Special Functions Screen

Generic OBDII Operations

A fast-access option for OBDII/EOBD vehicle diagnosis is available on the Vehicle Menu screen. This option presents a quick way to check for DTCs, isolate the cause of an illuminated malfunction indicator lamp (MIL), check monitor status prior to emissions certification testing, verify repairs, and perform a number of other services that are emissions-related. The OBD direct access option is also used for testing OBDII/EOBD compliant vehicles that are not included in the Diagnostics database.

Functions of the diagnostics toolbar buttons at the top of the screen are the same as those available for specific vehicle diagnostics. See [Table 4-2 Operation Toolbar Buttons](#) for details.

General Procedure

- **To access the OBDII/EOBD diagnostics functions**
 1. Tap the **Diagnostics** application button from the MaxiIM Job Menu. The Vehicle Menu displays.
 2. Tap the **EOBD** button. There are two options to establish communication with

the vehicle.

- **Auto Scan** — when this option is selected the diagnostic tool attempts to establish communication using each protocol in order to determine which one the vehicle is broadcasting on.
 - **Protocol** — when this option is selected the screen opens a submenu of various protocols. A communication protocol is a standardized way of data communication between an ECM and a diagnostic tool. Global OBD may use several different communication protocols.
3. Select a specific protocol under the **Protocol** option. Wait for the OBDII Diagnostic Menu to appear.

 **NOTE**

Tap the  button beside the function name to display additional information.

4. Select a function option to continue.
 - **DTC & FFD**
 - **I/M Readiness**
 - **Live Data**
 - **O₂ Sensor Monitor**
 - **On-Board Monitor**
 - **Component Test**
 - **Vehicle Information**
 - **Vehicle Status**

 **NOTE**

Some functions are supported only on certain vehicles.

Function Descriptions

This section describes the various functions of each diagnostic option:

DTC & FFD

When this function is selected, the screen displays a list of Stored Codes and Pending Codes. When the Freeze Frame data of certain DTCs are available for viewing, a snowflake button will display on the right side of the DTC item.

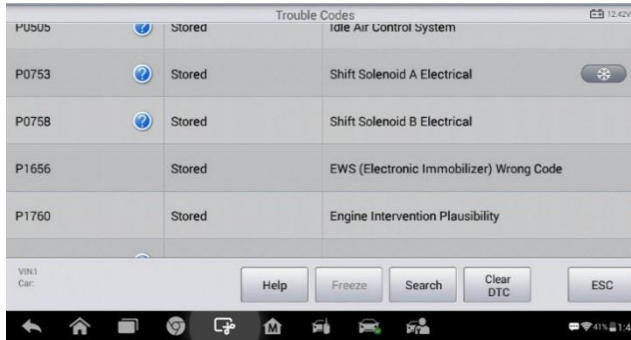

Figure 6-9 Sample DTC & FFD Screen

The erase codes function can be applied by tapping the **Clear DTC** button at the bottom of the screen.

- **Stored Codes**

Stored codes are the current emission related DTCs from the ECM of the vehicle. OBDII/EOBD Codes have a priority according to their emission severity, with higher priority codes overwriting lower priority codes. The priority of the code determines the illumination of the Malfunction Indicator Light (MIL) and the codes erase procedure. Manufacturers rank codes differently, so expect to see differences between vehicles.

- **Pending Codes**

These are codes whose setting conditions were met during the last drive cycle, but need to be met on two or more consecutive drive cycles before the DTC actually sets. The intended use of this service is to assist the service technician after a vehicle repair and after clearing diagnostic information, by reporting test results after a driving cycle.

- If a test failed during the driving cycle, the DTC associated with that test is reported. If the pending fault does not occur again within 40 to 80 warm-up cycles, the fault is automatically cleared from memory.
- Test results reported by this service do not necessarily indicate a faulty component or system. If test results indicate another failure after additional driving, then a DTC is set to indicate a faulty component or system, and the MIL is illuminated.

- **Freeze Frame**

In most cases the stored frame is the last DTC that occurred. Certain DTCs, which have a greater impact on vehicle emission, have a higher priority. In these cases, the top prioritized DTC is the one for which the freeze frame records are retained. Freeze frame data includes a “snapshot” of critical parameter values at the time the DTC is set.

- **Clear DTC**

This option is used to clear all emission related diagnostic data such as, DTCs, freeze frame data and manufacturer specific enhanced data from the vehicle's ECM.

A confirmation screen displays when the clear codes option is selected to prevent accidental loss of data. Select **Yes** on the confirmation screen to continue or **No** to exit.

I/M Readiness

This function is used to check the readiness of the monitoring system. It is an excellent function to use prior to having a vehicle inspected for compliance to a state emissions program. Selecting I/M Readiness opens a submenu with two choices:

- **Since DTCs Cleared** — displays the status of monitors since the last time the DTCs are erased.
- **This Driving Cycle** — displays the status of monitors since the beginning of the current drive cycle.

Live Data

This function displays the real time PID data from ECU. Displayed data includes analog inputs and outputs, digital inputs and outputs, and system status information broadcast on the vehicle data stream.

Live data can be displayed in various modes, see [Live Data](#) for detailed information.

O₂ Sensor Monitor

This option allows retrieval and viewing of O₂ sensor monitor test results for the most recently performed tests from the vehicle's on-board computer.

The O₂ Sensor Monitor test function is not supported by vehicles that communicate using a controller area network (CAN). For O₂ Sensor Monitor tests results of CAN-equipped vehicles, refer to [On-Board Monitor](#).

On-Board Monitor

This option allows you to view the results of On-Board Monitor tests. The tests are useful after servicing or after erasing a vehicle's control module memory.

Component Test

This service enables bi-directional control of the ECM so that the diagnostic tool is able to transmit control commands to operate the vehicle systems. This function is useful in determining whether the ECM responds to a command well.

Vehicle Information

The option displays the vehicle identification number (VIN), the calibration identification, and the calibration verification number (CVN), and other information of the test vehicle.

Vehicle Status

This item is used to check the current condition of the vehicle, including communication protocols of OBDII modules, retrieved codes amount, status of the Malfunction Indicator Light (MIL), and other additional information.

Exiting Diagnostics

The Diagnostics application remains open as long as there is an active communication with the vehicle. You must exit the diagnostics operation to stop all communications with the vehicle before closing the Diagnostics application.

NOTE

Damage to the vehicle electronic control module (ECM) may occur if communication is disrupted. Make sure all connections, such as USB cable and wireless connection, are properly connected at all times during testing. Exit all tests before disconnecting the test connection or powering down the tool.

➤ To exit the Diagnostics application

1. From an active diagnostic screen, tap the **Back** or **ESC** function button to exit a diagnostic session step-by-step.
2. Or tap the **Vehicle Swap** button on the diagnostics toolbar to return to the Vehicle Menu screen.
3. From the Vehicle Menu screen, tap the **Home** button on the top toolbar; or tap the **Back** button on the navigation bar at the bottom of the screen.
4. Or tap the **Home** button on the diagnostics toolbar to exit the application directly and go back to the MaxiIM Job Menu.

Now, the Diagnostics application is no longer communicating with the vehicle and it is safe to open other MaxiIM applications, or exit the MaxiIM Diagnostic System and return to the Android System's Home screen.

7. Service

The Service section is specially designed to provide you with quick access to the vehicle systems for various scheduled service and maintenance performances. The typical service operation screen is a series of menu driven executive commands. By following the on-screen instructions to select appropriate execution options, enter correct values or data, and perform necessary actions, the system will guide you through the complete performance for various service operations.

The most commonly performed service functions include:

- Oil Reset Service
- EPB Service
- BMS Service
- SAS Service
- DPF Service
- TPMS Service

After entering each special function, the displayed screen consists of two applications: **Diagnosis** and **Hot Functions**. The **Diagnosis** is for you to read/clear data since this is necessary after some special functions. **Hot Functions** consists of sub functions of the selected special function.

Oil Reset Service

This function allows you to perform reset for the Engine Oil Life system, which calculates an optimal oil life change interval depending on the vehicle driving conditions and climate. The Oil Life Reminder must be reset every time the oil is changed, so the system can calculate when the next oil change is required.

! IMPORTANT

Always reset the engine oil life to 100% after every oil change.

🔧 NOTE

- All required work must be carried out before the service indicators are reset. Failure to do so may result in incorrect service values and cause DTCs to be stored by the relevant control module.
 - For some vehicles, the scan tool can perform added functionality to reset additional service lights (maintenance cycle, service interval). Taking BMW as an example, its service reset function includes engine oil, spark plugs, front/rear brakes, coolant, particle filter, brake fluid, micro filter, vehicle inspection, exhaust emission inspection and vehicle check.
-

All software screens shown in this manual are examples, actual test screens may vary for each vehicle being tested. Observe the menu titles and on-screen instructions to make correct option selections.

➤ **To perform oil reset functions**

1. Tap the **Service** application button from the MaxiIM Job Menu.
2. Tap **Oil Reset** button and wait for the vehicle manufacturer screen. You can tap **VIN Scan** or the vehicle make to acquire vehicle VIN information and tap **Yes** to confirm. See [Vehicle Identification](#) for details.
3. Tap the function you want in the Oil Reset function list, the list may vary for different vehicles being tested.

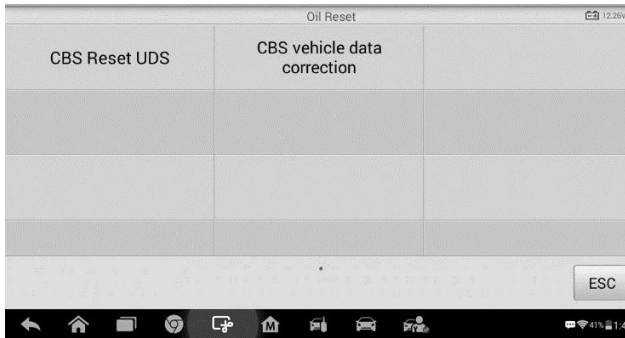

Figure 7-1 Sample Oil Reset Function List

4. Follow the step-by-step on-screen instruction to complete the service. Take CBS Reset UDS as an example.
5. Tap **CBS Reset UDS** on the Oil Reset function list to start the operation. The screen will guide you to confirm the date and time, if the displayed date and time are correct, tap **Yes** to confirm. If not, tap **No** and go to the Settings menu to set the correct date and time.

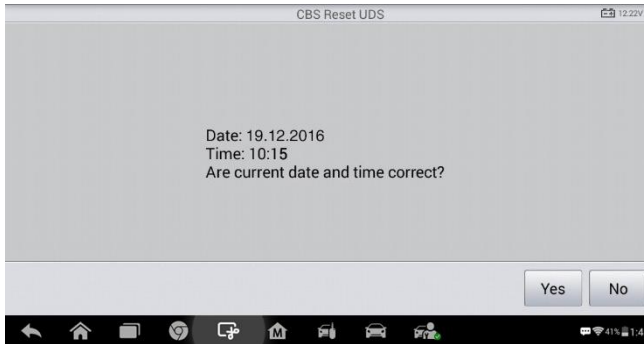

Figure 7-2 Sample Oil Reset Service Screen 1

6. On the next screen, the available items would be listed with three columns displayed: CBS value, availability, and service counter.
7. Tap on the value you want to reset and then tap the **Reset** button on the right bottom of the screen.

The screenshot shows a mobile application interface titled 'CBS Reset UDS'. It displays a table with three columns: 'CBS value', 'availability', and 'service counter'. The table contains the following data:

| CBS value | availability | service counter |
|-------------|--------------|-----------------|
| Engine oil | 32 % | 5 |
| Front Brake | 97 % | 9 |
| Rear Brake | 96 % | 6 |

At the bottom right of the screen, there are two buttons labeled 'Reset' and 'ESC'. The bottom of the screen features a standard Android navigation bar. The status bar at the very bottom shows a battery level of 41% and the time 1:42.

Figure 7-3 Sample Oil Reset Service Screen 2

8. When the reset is done, the availability would display as 100%. Tap **ESC** to exit.

Electronic Parking Brake (EPB) Service

This function has a multitude of usages to maintain the electronic braking system safely and effectively. The applications include deactivating and activating the brake control system, assisting with brake fluid control, opening and closing brake pads, and setting brakes after disc or pad replacement, etc.

EPB Safety

It may be dangerous to perform Electronic Parking Brake (EPB) system maintenance, so before you begin the service work, please keep these rules in mind.

| CBS Reset UDS | | |
|---------------|-------|---|
| Engine oil | 32 % | 5 |
| Front Brake | 97 % | 9 |
| Rear Brake | 96 % | 6 |
| Brake fluid | 100 % | 6 |

Reset ESC

Figure 7-4 Sample Oil Reset Service Screen 3

- ✓ Ensure that you are fully familiar with the braking system and its operation before commencing any work.
- ✓ The EPB control system may be required to be deactivated before carrying out any maintenance/diagnostic work on the brake system. This can be done from the tool menu.
- ✓ Only carry out maintenance work when the vehicle is stationary and on level ground.
- ✓ Ensure that the EPB control system is reactivated after the maintenance work has been completed.

NOTE

Autel accepts no responsibility for any accident or injury arising from the maintenance of the Electronic Parking Brake system.

➤ **To perform EPB functions**

1. Tap the **Service** application button from the MaxiIM Job Menu.
2. Tap **EPB** button and wait for the vehicle manufacturer screen. You can tap **VIN Scan** or the vehicle make to acquire vehicle VIN information and tap **Yes** to confirm. See [Vehicle Identification](#) for details.
3. Tap the service you want in the EPB function list, the list may vary for different vehicles being tested.

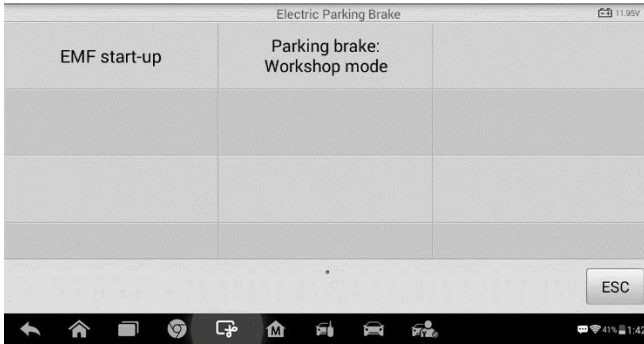

Figure 7-5 Sample EPB Function List

4. Follow the step-by-step on-screen instruction to complete the service.
5. Press **OK** button to exit.

EMF Start-up

This service function would start up the parking brake, it must be conducted after the following repairs:

- Replacing an EMF control unit.
- Replacing the parking brake button.

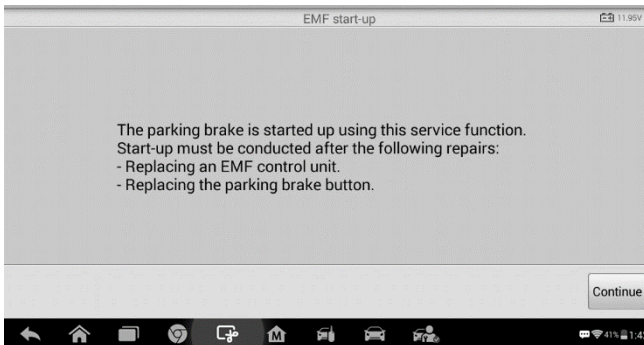

Figure 7-6 Sample EMF Start-up Screen 1

- 1) Tap **Continue** to proceed this service function or the **Back** button at the bottom left to exit.
- 2) Tap on the action that has been carried out to continue.

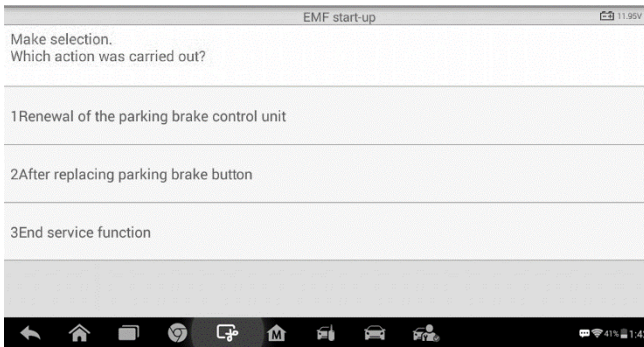

Figure 7-7 Sample EMF Start-up Screen 2

- 3) In the following step, the screen will remind you that the fault memory of the parking brake control unit will be deleted, press **Continue** to proceed or the **Back** button to exit.

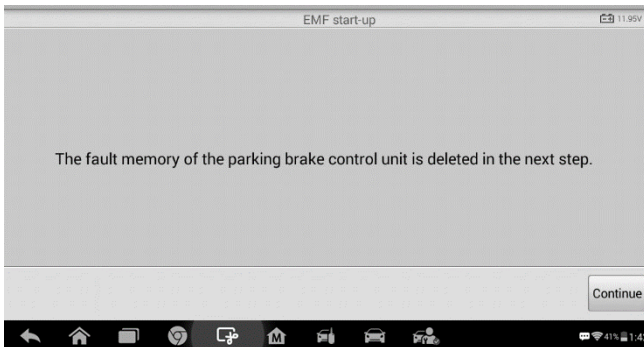

Figure 7-8 Sample EMF Start-up Screen 3

- 4) Follow the on-screen instructions to pull the parking brake button and wait for around 3 seconds until the parking brake is set. When the operation is successfully completed, a “Completed successfully” message will appear on the screen. Press **OK** to exit.

Parking Brake: Workshop Mode

This service is used to activate and deactivate the so-called installation position for the Automatic Hold brake. In this mode the parking brake is moved into the opened position and temporarily deactivated for personal protection.

The installation position must be activated for the following repairs:

- Replacement of brake pads.
- Replacement of a brake caliper.
- Replacement of an actuator.

Select **Parking Brake: Workshop Mode** and follow the on-screen instructions to perform a series of operations to start the brake pad after replacement.

When the operation is successfully completed, a “Completed successfully” message will appear on the screen. Press **OK** to exit.

BMS

The BMS (Battery Management System) allows the scan tool to evaluate the battery charge state, monitor the close-circuit current, register the battery replacement, and activate the rest state of the vehicle.

NOTE

1. This function is not supported by all vehicles. The screens shown in this section are examples.
2. The sub functions and actual test screens of the BMS may vary for different test vehicles, please follow the on-screen instructions to make correct option selection.

The vehicle may use either a sealed lead-acid battery or an AGM (Absorbed Glass Mat) battery. Lead acid battery contains liquid sulphuric acid and can spill when overturned. AGM battery (known as VRLA battery, valve regulated lead acid) also contains sulphuric acid, but the acid is contained in glass mats between terminal plates.

It is recommended that the replacement aftermarket battery has the same specifications, such as capacity and type, with the battery used in the vehicle. If the original battery is replaced with a different type of battery (e.g. a lead-acid battery is replaced with an AGM battery) or a battery with a different capacity (mAh), the vehicle may require reprogramming the new battery type in addition to performing the battery reset. Consult the vehicle manual for additional vehicle-specific information.

Register Battery Replacement

This option allows displaying the mileage reading of last battery replacement, registering the battery replacement after replacing a new battery and informing the power management system that a new battery has been fitted to the vehicle.

If the battery change is not registered, the power management system will not function properly, which may not provide the battery with enough charging power to operate the car and limit the functions of individual electrical equipment.

Take **BMW** as an example.

➤ To display the battery history

1. Tap the **Service** application button from the MaxiIM Job Menu.
2. Tap **BMS** button and wait for the vehicle manufacturer screen. You can tap **VIN Scan** or the vehicle make to acquire vehicle VIN information and tap **Yes** to confirm. See [Vehicle Identification](#) for details.
3. Tap **Register Battery Replacement** in the EPB function list, the list may vary for different vehicles being tested.

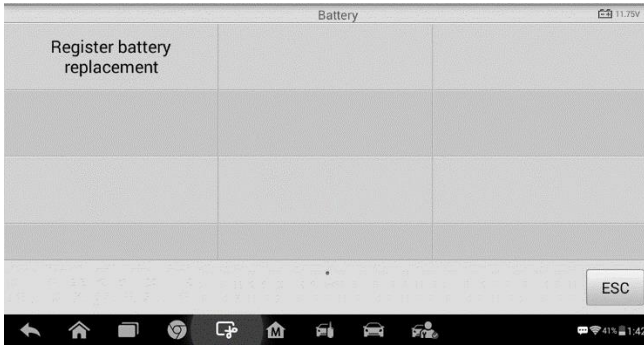

Figure 7-9 Sample BMS Function List

4. Tap on the corresponding service you want to carry out. In this case, it is function **1 Display kilometer reading at last battery change and one before last**. A notice screen displays.

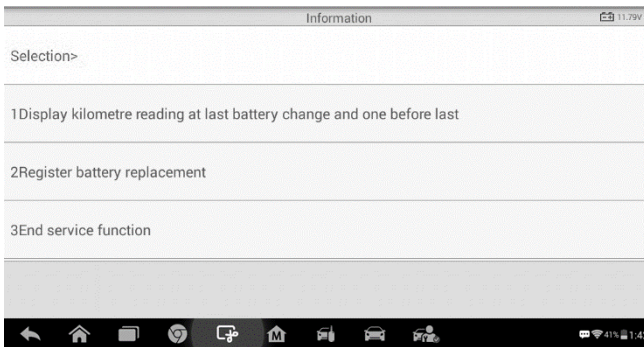

Figure 7-10 Sample BMS Screen 1

5. Read carefully the complete information and press **Continue** to continue.

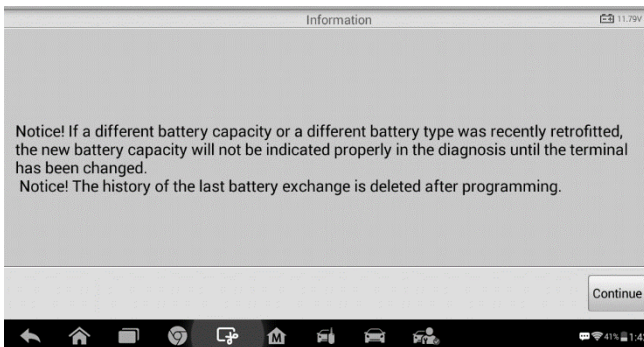

Figure 7-11 Sample BMS Screen 2

6. Check the battery capacity and the battery replacement information on the screen.
7. Tap on the corresponding function 1 to return to the selection screen or press the function 2 to end the service function.

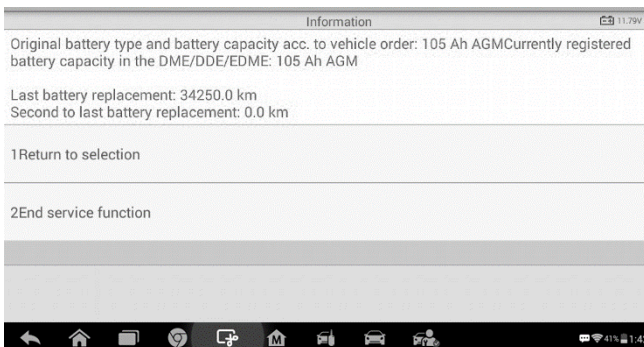

Figure 7-12 Sample BMS Screen 3

➤ **To register the battery replacement**

1. Tap on the corresponding service you want to carry out. In this case, it is function 2 **Register battery replacement**.

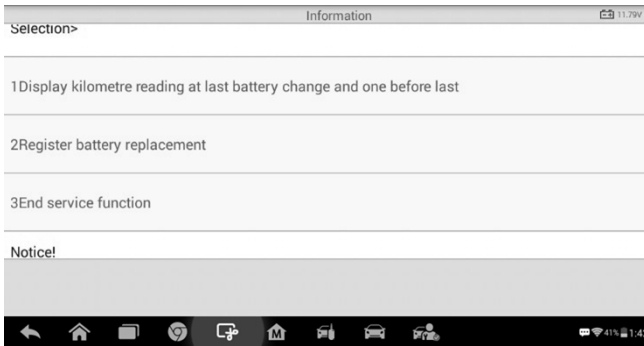

Figure 7-13 Sample BMS Screen 4

2. Read carefully the information on the screen and slide up/down to view all the functions listed.

There are four functions listed:

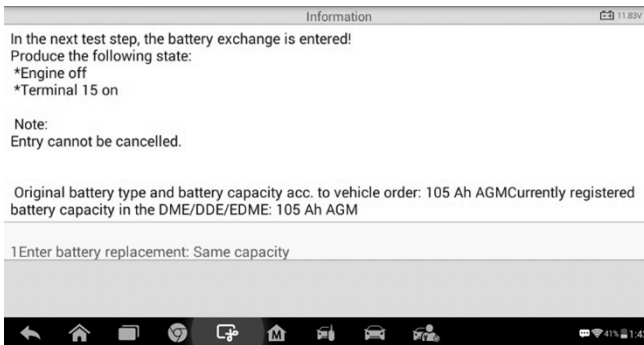

Figure 7-14 Sample BMS Screen 5

- 1) Enter battery replacement: Same capacity
- 2) Enter battery replacement: Different capacity
- 3) Enter battery replacement: Changing from the normal lead-acid battery (white housing) to AGM battery (black housing)
- 4) End service function.

Take the first function as an example.

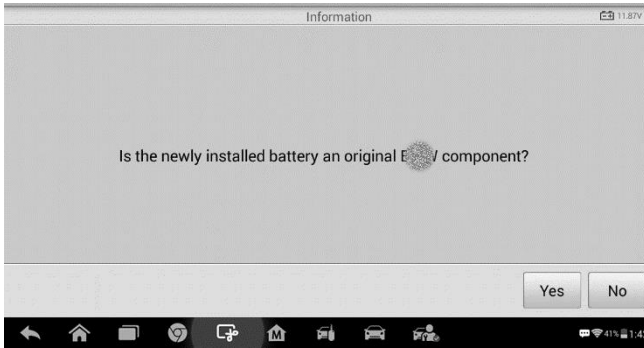

Figure 7-15 Sample BMS Screen 6

1. Read carefully the information on the screen and tap **Yes** to continue.
2. Follow the on-screen instructions to input the data matrix code of the newly installed battery which should be on the label of the battery. Tap **OK** to continue.

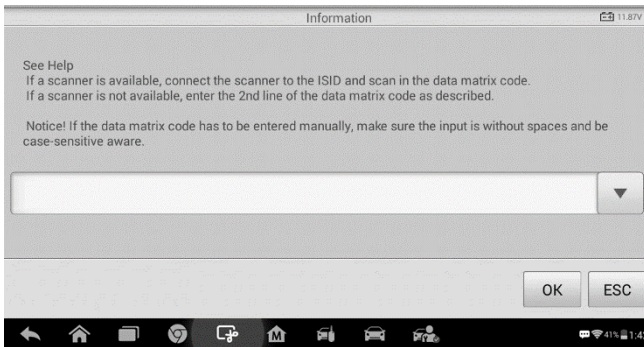

Figure 7-16 Sample BMS Screen 7

3. When the battery exchange is successfully entered, tap **Continue** to complete the operation.

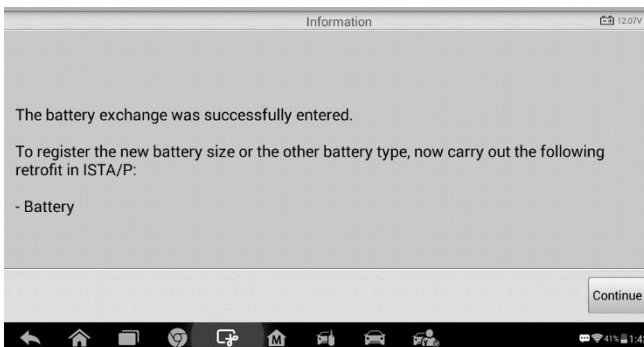

Figure 7-17 Sample BMS Screen 8

Steering Angle Sensor (SAS) Service

Steering Angle Sensor Calibration permanently stores the current steering wheel position as the straight-ahead position in the steering angle sensor EEPROM. Therefore, the front wheels and the steering wheel must be set exactly to the straight-ahead position before calibration. In addition, the vehicle identification number is also read from the instrument cluster and stored permanently in the steering angle sensor EEPROM. On successful completion of calibration, the steering angle sensor fault memory is automatically cleared.

Calibration must always be carried out after the following operations:

- Steering wheel replacement
- Steering angle sensor replacement
- Any maintenance that involves opening the connector hub from the steering angle sensor to the column
- Any maintenance or repair work on the steering linkage, steering gear or other related mechanism
- Wheel alignment or wheel track adjustment
- Accident repairs where damage to the steering angle sensor or assembly, or any part of the steering system may have occurred

NOTE

- Autel accepts no responsibility for any accident or injury arising from servicing the SAS system. When interpreting DTCs retrieved from the vehicle, always follow the manufacturer's recommendation for repair.
- All software screens shown in this manual are examples, actual test screens may vary for each vehicle being tested. Observe the menu titles and on-screen instructions to make correct option selections.
- Before starting the procedure, make sure the vehicle has an ESC button. Look for the button on dash.

Take **Land Rover** as an example.

1. Tap the **Service** application button from the MaxiIM Job Menu.
2. Tap **SAS** button and wait for the vehicle manufacturer screen. You can tap **VIN Scan** or the vehicle make to acquire vehicle VIN information and tap **Yes** to confirm. See [Vehicle Identification](#) for details.
3. Tap the service you want in the SAS function list, the list may vary for different vehicles being tested.

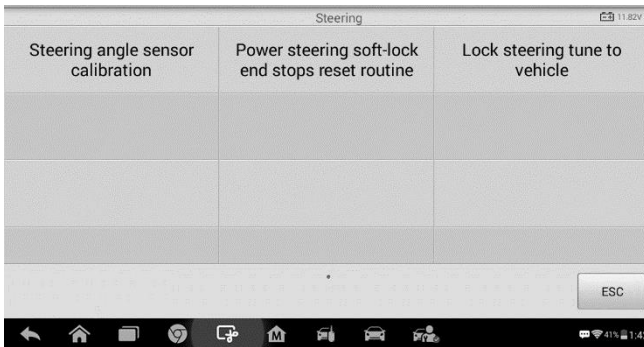

Figure 7-18 Sample SAS Function Menu

Steering Angle Sensor Calibration

This function allows users to perform steering angle sensor calibration and clear records. The function options vary with the vehicles being tested.

- 1) Tap **Steering Angle Sensor Calibration** from the SAS function menu to enter the function screen.
- 2) Follow the on-screen instructions to set the ignition on/off as guided. The vehicle battery voltage signal should be in the range 12.5 – 13.5 volts to proceed this service, otherwise the scan tablet will display a warning message.
- 3) Make sure the steering wheel is in the central position and the front wheels are in the straight position. Then tap **OK** to proceed.

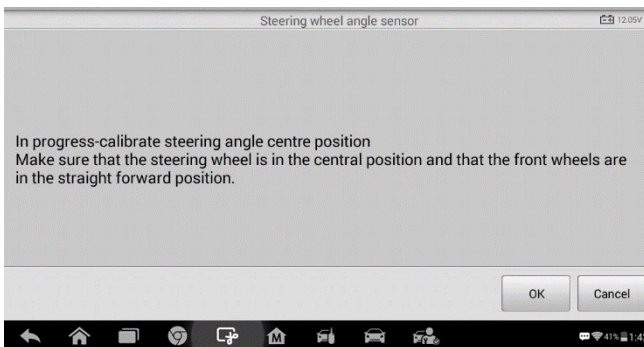

Figure 7-19 Sample SAS Function Screen 1

- 4) When the operation is completely finished, the scan tool will display a confirmation message. Otherwise, it will display a message to remind you of a problem. After you exit the diagnosis program, please repair the problem immediately.

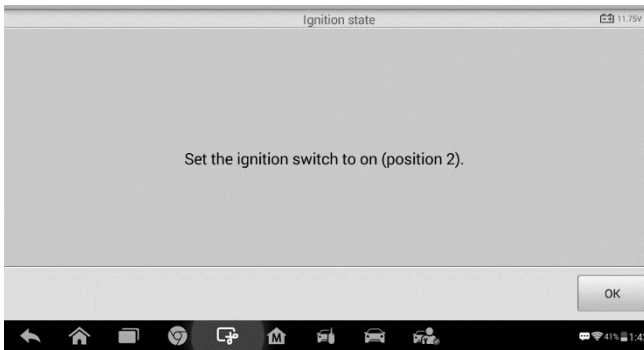

Figure 7-20 Sample SAS Function Screen 2

DPF Service

The DPF function allows you to carry out numerous functions to the Diesel Particulate Filter system without having to send your car to a main dealer. The tool will manage DPF regeneration, DPF component replacement teach-in and DPF teach-in after replacing the engine control unit.

ECM monitors driving style and selects a suitable time to employ regeneration. Cars driven a lot at idling speed and low load will attempt to regenerate earlier than cars driven more with high load and high speed. In order for regeneration to take place, a prolonged high exhaust temperature must be obtained.

In the event of the car being driven in such a way that regeneration is not possible, i.e. frequent short journeys, a diagnostic trouble code will eventually be registered, DPF light and “Check Engine” indicator comes on. A service regeneration can be requested in the workshop, using the diagnostic tool.

Before carrying out a forced DPF regeneration using the tool, check the following items:

- The fuel light is not on.
- No DPF-relevant faults stored in system.
- The vehicle has the correct spec engine oil.
- The oil for diesel is not contaminated.

IMPORTANT

Before diagnosing a problem vehicle and attempting to perform an emergency regeneration, it is important to obtain a full diagnostic log and read out relevant measured value blocks.

NOTE

- The DPF will not regenerate if the engine management light is on, or there is a faulty EGR valve.
-

- The ECU must be re-adapted when replacing the DPF and when topping up the fuel additive Eolys.
- If the vehicle needs to be driven in order to perform a DPF service, ALWAYS have a second person help you. One person should drive the vehicle while the other person observes the screen on the Tool. Trying to drive and observe the Scan Tool at the same time is dangerous, and could cause a serious traffic accident.

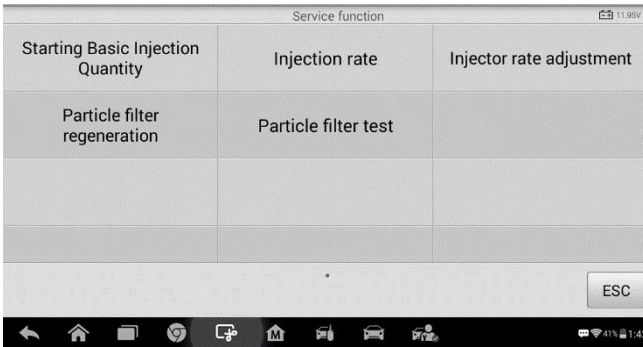

Figure 7-21 Sample DPF Service Function Menu

Starting Basic Inspection Quantity

This function enables you to start fuel delivery matching.

1. Tap **Starting Basic Inspection Quantity** from the service functions menu to enter the service screen.
2. The tool communicates with the vehicle and reads the fault codes memory. Follow the on-screen instructions to finish this procedure.
3. The tool will display a function list menu as below. Press the corresponding number button to perform the desired function.

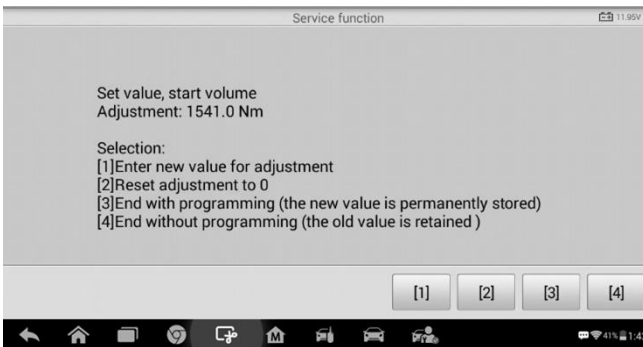

Figure 7-22 Sample Starting Basic Inspection Quantity

[1] Enter New Value for Adjustment

From the **Starting Basic Inspection Quantity** menu, tap [1] and the screen displays as below.

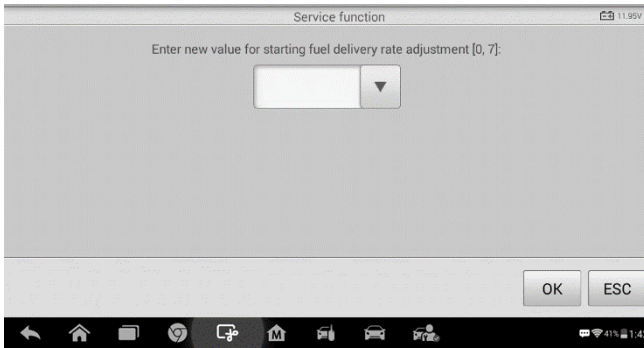

Figure 7-23 Sample Enter New Value Screen

After entering the value, tap **OK** to save the value to the tool. Tap **ESC** to exit the operation.

NOTE

The data you input should be in the range given. If the input data is out of range, the tool will display a warning message "Permissible adjustment range exceeded."

[2] Reset Adjustment to 0

Once the [2] is tapped, the tool will automatically reset the value to zero.

[3]/[4] Store Data and Exit

When the fuel delivery rate adjustment is completed, tap [3] to store the new value in the control units; or select [4] and **OK** to retain the old value.

Injection Rate

This function is used to adjust the injection volume.

1. Tap **Injection Rate** from the service functions menu to enter the service screen.
2. The tool communicates with the vehicle and reads the fault codes memory. Follow the on-screen instructions to finish this procedure.
3. Then the tool will display as below. Press the corresponding number button to perform the desired function.

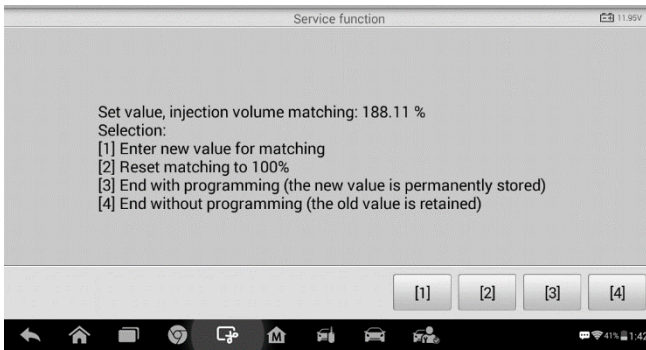

Figure 7-24 Sample Injection Rate Screen

[1] Enter New Value for Matching

From the **Injection Rate** menu, tap **[1]** and the screen displays as below.

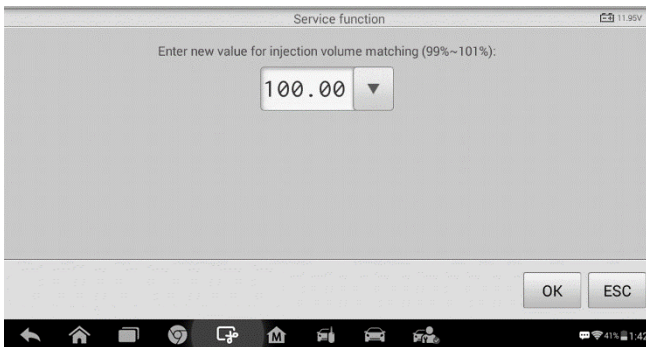

Figure 7-25 Sample Enter Value Screen

NOTE

The data you input should be in the reasonable range. If the input data is out of range, the tool will display a warning message “Permissible adjustment range exceeded.”

[2] Reset Matching to 100%

Once the **[2]** is pressed, the tool will automatically reset the value to 100%.

[3]/[4] Store Data and Exit

When the injection volume adjustment is completed, select **[3]** and **OK** to store the new value in the control units; or select **[4]** and **OK** to retain the old value.

Injector Rate Adjustment

This function is used to adjust the injector rate for individual cylinders.

1. Tap **Injection rate adjustment** from the service functions menu.

2. The tool communicates with the vehicle and reads the fault codes memory. Follow the on-screen instructions to enter the service function.
3. Tap the corresponding number button to enter new value for each cylinder.
4. Follow the on-screen instructions to tap on the corresponding number **[1] [2] [3] [4]** to enter the new value for the cylinder, restore the old value, and exit after finish the function.

Particle Filter Regeneration

This function is used to perform the particle filter regeneration.

1. Tap **Particle filter regeneration** from the service functions menu.
2. The tool communicates with the vehicle and reads the fault codes memory. Follow the on-screen instructions to check the prerequisites before particle filter regeneration, such as the fuel, the time and driving style.
3. If every prerequisite is met, the tool will ask your confirmation to proceed as below. Tap **Request** to begin a regeneration or **End** to end the service function and exit.

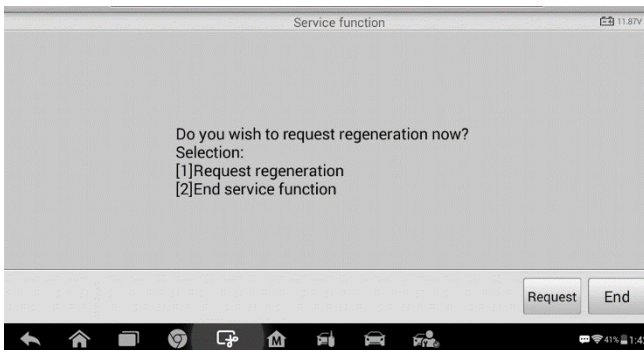

Figure 7-26 Sample Regeneration Confirmation Screen

4. A series of instruction screens appears for users to perform the particle filter regeneration step by step. Follow the onscreen instructions and tap **OK** button until the tool reads off the regeneration status as below.

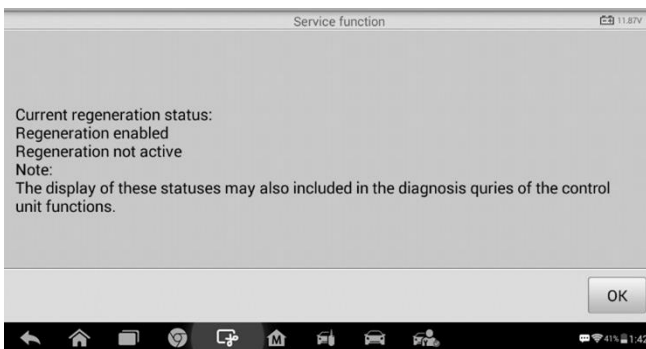

Figure 7-27 Sample Regeneration Status Screen

5. When the particle filter regeneration is complete, the tool will ask your confirmation to exit the display. Tap **Repeat** to check the status again or **End** to end the service function and exit.

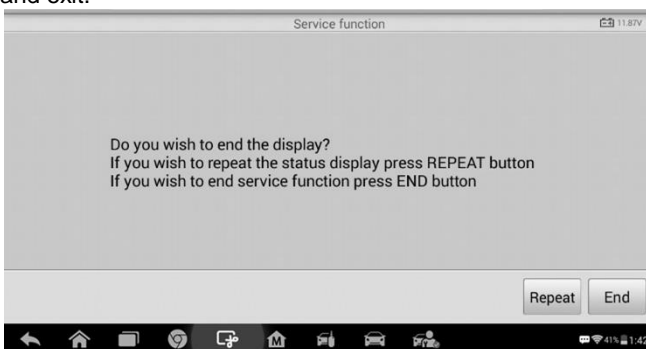

Figure 7-28 Sample Repeat Screen

NOTE

In the case of a particle filter heavily loaded with soot, it can occur that the regeneration request is blocked again after a short time or is not released. In this case, it is required to regenerate the particle filter in a motorway or cross-country trip taking approx. 30 minutes at a speed that is as constant as possible. Subsequently, the service function “Particle filter regeneration” must be run again.

During the regeneration phase and with the engine running, it can also occur that the display for “Regeneration active” jumps to “Regeneration not active”. This behavior can be seen exclusively with the vehicle stationary with the engine.

Particle Filter Test

It is advisable to carry out a series of particle filter tests as a result of constant DPF regeneration, such as checking oil level, oil change interval for diesel contamination, swirl flaps, backpressure sensors and particle filter soot remains.

1. Tap **Particle filter test** from the service functions menu.
2. The tool communicates with the vehicle and reads the fault codes memory. If there is no relevant fault code stored in DDE, the screen displays as below. Select **Cancel** to exit this function.
3. If there are DPF-related codes stored in DDE, the screen displays as below. Select **OK** to continue or **Cancel** to exit this function.

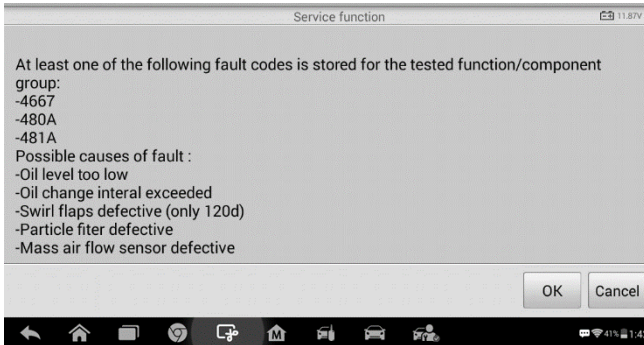

Figure 7-29 Sample Codes Screen

4. The tool shows a list of particle filter test. Select the corresponding number button to perform the desired test **[1] [2] [3] [4] [5]**.
 - [1]** Visual Inspection of Engine Oil
 - [2]** Visual Inspection of Particulate Filter
 - [3]** Function Check or Swirl Flaps
 - [4]** Exhaust Backpressure Test
 - [5]** Actual/Target Value Check-Mass Air Flow Sensor

Tire Pressure Monitor System (TPMS) Service

This function allows you to quickly look up the tire sensor IDs from the vehicle's ECU, as well as to perform TPMS replacement and sensor test.

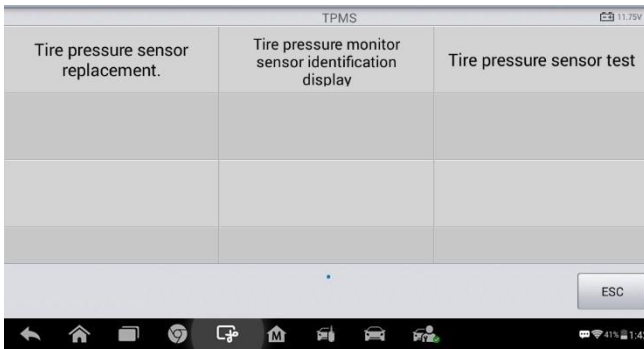

Figure 7-30 Sample TPMS Function Menu

Take Tire pressure sensor replacement (Front left wheel sensor) as an example.

NOTE

During this application the wheel unit 8-digit identifications will need to be entered using the screen displayed.

The sensor identifications can be accessed by reading directly from the wheel unit or by using the identification reading tool.

On completion, a specific road test will be required followed by the tire pressure monitor system application.

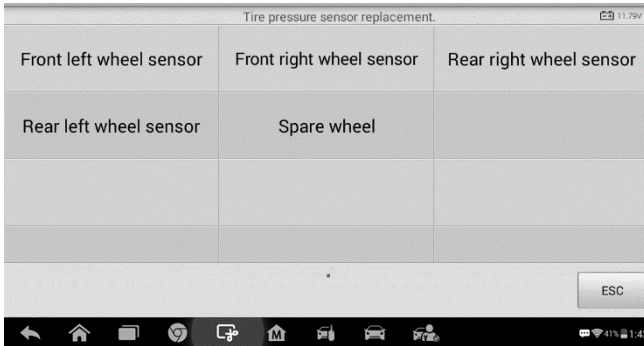

Figure 7-31 Sample Tire Pressure Sensor Replacement Screen

- 1) Tap **Front left wheel sensor** in the tire pressure sensor replacement menu.
- 2) Enter the 8 digit sensor identification as required.

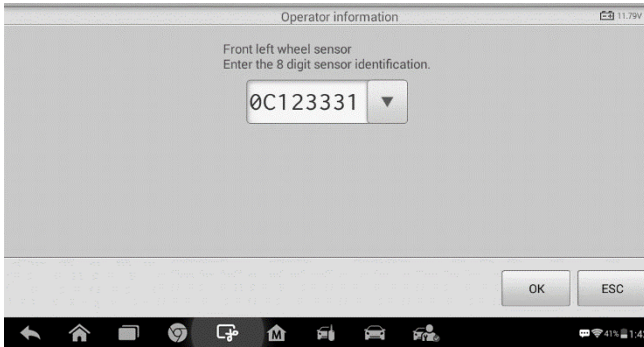

Figure 7-32 Sample Sensor ID Input Screen

- 3) The scan tablet will carry out the service and the screen will remind you the test has passed and all the selected tire pressure sensor identification numbers programmed successfully.

NOTE

The vehicle must remain stationary for at least 15 minutes with the ignition off, this will place the sensors into sleep mode. The vehicle must be driven for at least 15 minutes at a speed higher than 20 kph to ensure the module has learnt the sensor identifications and positions.

For other services, please follow the on-screen instructions to operate.

On completion of the drive cycle, carry out the tire pressure monitor system test application.

8. Update

The Update application allows you to download the latest released software. The updates can improve the MaxiIM applications' capabilities, typically by adding new tests, new models, or enhanced applications to the database.

The tablet automatically searches for available updates for all of the MaxiIM software when it is connected to the Internet. Any updates that are found can be downloaded and installed on the device. This section describes installing an update to the MaxiIM System. A notification message displays if an update is available when the Notifications Center function is enabled in the Settings application.

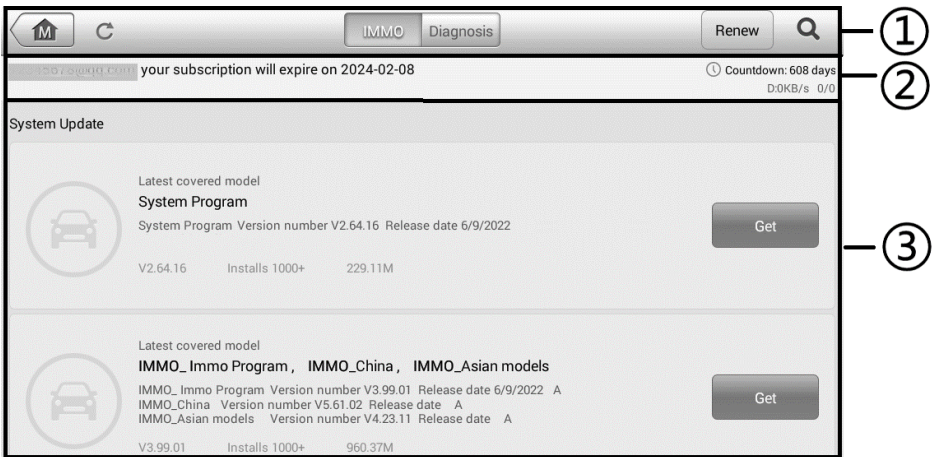

Figure 8-1 Sample Update Screen

1. Navigation and Controls

- Home Button — returns to the MaxiIM Job Menu.
- Refresh — refreshes the available update list.
- IMMO Tab — displays all available IMMO software for vehicles.
- Diagnostics Tab — displays all available vehicle diagnostics software.
- Renew — renews the subscription.
- Search Bar — search specific update item by inputting the file name, for example: a specific vehicle manufacturer.

2. Status Bar

- Left Side — displays your account email address and expiration date of your subscription.

- Right Side — shows the remaining days of your subscription and real-time Internet speed amid downloading.

3. Main Section

- Left Column — displays vehicle logos.
- Middle Column — displays a brief introduction about the new changes to the software operation or capabilities.
- Right Column — according to the operation status of each software item, the button displays differently.
 - ✧ Tap the sort type button to sort available items in desired type.
 - ✧ Tap **Bulk update** to batch update selected items.
 - ✧ Tap **Get** to update the item.
 - ✧ Tap **Pause** to suspend the update.
 - ✧ Tap **Continue** to resume the update.

➤ To update the IMMO software and diagnostic software

1. Make sure the tablet is connected to a power source with stable access to the Internet.
2. Tap the **Update** application button from the MaxiIM Job Menu; or tap the update notification message when received one; or tap the **Update** icon on Vehicle Menu in IMMO/Diagnostics application. The Update application screen displays.
3. Check all available updates and select the desired tab:
 - If you decide to update all the items, tap **Bulk update > Select all**.
 - If you decided to update more than one items, tap the **Bulk update** button and selected the desired items.
 - If you only want to update one item, tap the **Get** button on the right column of the item.
4. Tap the **Pause** button to suspend the updating process. Tap **Continue** to resume the update and the process will continue from the pause point.
5. When the updating process is completed, the firmware will be installed automatically. The new version will replace the older version.

9. Settings

Selecting Settings application opens a setup screen, on which you can adjust default setting and view information about the MaxiIM system. The following shows options available for the MaxiIM system settings:

- **Unit**
- **Language**
- **Printing Settings**
- **Report Settings**
- **Firmware Upgrade**
- **Multitask**
- **Auto Update**
- **Car Order**
- **System Settings**
- **About**

This section describes the operation procedures for the settings.

Unit

This option allows you to adjust the measurement unit for the diagnostic system.

- **To adjust the unit setting**
 1. Tap the **Settings** application on the MaxiIM Job Menu.
 2. Tap the **Unit** option on the left column.
 3. Select the required measurement unit, Metric or Imperial. A check mark will display to the right of the selected unit.
 4. Tap the **Home** button on the top left corner to return to the MaxiIM Job Menu. Or select another setting option for system setup.

Language

This option allows you to adjust the display language for the MaxiIM system.

➤ **To adjust the language setting**

1. Tap the **Settings** application on the MaxiIM Job Menu.
2. Tap the **Language** option on the left column.
3. Select the required language. A check mark will display to the right of the selected language.
4. Tap the **Home** button on the top left corner to return to the MaxiIM Job Menu. Or select another setting option for system setup.

Printing Settings

This option allows you to print any data or information through a PC via Wi-Fi connection.

➤ **To set up the printer connection**

1. Tap the **Settings** application on the MaxiIM Job Menu.
2. Tap the **Printing Settings** option on the left column.
3. Tap the **Print via Network** item to activate the printing function, which enables the device to send files to the printer through the PC via Wi-Fi connection.
4. Tap the **Home** button on the top left corner to return to the MaxiIM Job Menu. Or select another setting option for system setup.

 **NOTE**

The PC and the tablet must be connected to the same network.

➤ **To install the printer driver program to a PC**

1. Download the Maxi PC Suite from www.autel.com > **Support** > **Downloads** > **Diagnostic Tool** and install to your PC.
2. Double click the **setup.exe** file.
3. Select the installation language and the wizard will load momentarily.
4. Follow the instructions on the screen and click **Next** to continue.
5. Click **Install**. The printer driver program will be installed onto the PC.
6. Click **Finish** to complete the installation.

➤ **To perform printing via PC**

1. Launch the **PC Link** application on the PC.
2. Click **Test Print** to make sure the printer is working successfully.
3. Tap the **Print** button on the toolbar of the tablet. A test file will be sent to the PC.

- If the **Auto Print** option on the **MaxiSys Printer** tab is selected, the received file is automatically printed.
- If the **Auto Print** option is not selected, click **Open PDF File** to view files. Select the file(s) to print and click **Print**.

Report Settings

This option automatically synchronizes the diagnostics information of the vehicle to the vehicle history and forms a diagnostics report for user to upload. Tap the **ON/OFF** button to enable/disable the Report Upload to Cloud function. The button displays blue if the function is enabled and displays gray if the function is disabled.

Firmware Upgrade

This option allows you to update the firmware of the built-in VCI module. Connect the tablet and the vehicle with the supplied main cable, ensure the tablet is connected to the Internet. The built-in VCI module will be automatically upgraded if a firmware update is available.

Multitask

The Multitask option allows you to turn the Multitask function on or off. The Multitask feature enables you to browse and navigate more freely among different applications on the MaxiIM system. Tap the Multi Task button, the Multi Task menu displays all active applications.

➤ To enable the Multitask function

1. Tap the **Settings** application on the MaxiIM Job Menu.
2. Tap the **Multitask** option on the left column.
3. Tap the **ON/OFF** button to enable or disable the Multitask function. If the function is enabled the button displays blue, or if disabled the button displays gray.
4. Tap the **Home** button on the top left corner to return to the MaxiIM Job Menu. Or select another setting option for the system setup.

Auto Update

The Auto Update allows the tool to automatically update the OS, the MaxiIM system, and the vehicle software. All you need to do is to switch ON by tapping the button on the right side of each and set the desired automatic update time.

➤ To enable the auto update

1. Tap the **Settings** application on the MaxiIM Job Menu.

2. Tap the **Auto Update** option on the left column. The three auto update items list on the right.
3. Select the update type to schedule. Toggle the button to **ON**.
4. Tap on the time to set time, you can use the **+** and **-** button or tap on the numbers then the manual input screen will pop up. Tap **Done** to complete the time setting.

 **NOTE**

Internet connection is necessary for auto update, otherwise it would not work even if you have already switch it on. Make sure the tool is connected to the Internet for the time you have set.

Car Order

This option allows you to sort the vehicles either by alphabetical order or by frequency of use.

➤ **To adjust the vehicle list setting**

1. Tap **Settings** on the MaxiIM Job Menu.
2. Tap **Car order** on the left column.
3. Select the desired sort type. A check mark will display to the right of the selected item.
4. Tap the **Home** icon on the top-left corner to return to the MaxiIM Job Menu, or select another setting option for the system setup.

System Settings

This option provides you a direct access to the Android background system setting screen, on which you can adjust various system settings for the Android system platform, regarding wireless and networks settings, various device settings such as display, system security settings, and check the associated information about the Android system.

➤ **To enable the App Switcher function**

1. Tap the **Settings** application on the MaxiIM Job Menu.
2. Tap the **System settings** option on the left column.
3. Tap the **App Switcher** option on the left column.
4. Mark the checkbox beside “Always show the App Switcher” on the right side of the screen, then the App Switcher icon shows.

Short press the **App Switcher** icon opens a control panel:

- Tap a specific app shortcut button enables you to switch directly to the selected application screen.
- Long press a specific app shortcut button displays the app menu, on which you can select and change the app shortcut.
- Press and drag the **App Switcher** icon around allows you to change the icon position alongside the edge of the screen.

You may refer to Android documentation for additional information about Android system settings.

About

The About option provides information of the MaxiIM diagnostic device regarding the product name, version, hardware, and serial number.

➤ **To check the MaxiIM product information in About**

1. Tap the **Settings** application on the MaxiIM Job Menu.
2. Tap the **About** option on the left column. The product information screen displays on the right.
3. Tap the **Home** button on the top left corner to return to the MaxiIM Job Menu, or select another setting option for the system setup after viewing.

10. Remote Desk

The Remote Desk application launches the TeamViewer Quick Support program, which is a simple, fast and secure remote control screen. You can use the application to receive ad-hoc remote support from Autel's support center, colleagues, or friends, by allowing them to control your MaxiIM tablet on their PC via the TeamViewer software.

If you think of a TeamViewer connection as a phone call, the TeamViewer ID would be the phone number under which all TeamViewer Clients can be reached separately. PCs and mobile devices that run TeamViewer are identified by a globally unique ID. The first time the Remote Desk application is started, this ID is generated automatically based on the hardware characteristics and will not change.

Make sure the tablet is connected to the Internet before launching the Remote Desk application, so that the tablet is able to receive remote support from the third party.



Figure 10-1 Sample Remote Desk Screen

➤ To receive remote support from a partner

1. Power on the tablet.
2. Tap the **Remote Desk** application on the MaxiIM Job Menu. The TeamViewer screen displays and the device ID is generated and shown.
3. Your partner must install the Remote Control software to his/her PC by downloading the TeamViewer full version program online (<http://www.teamviewer.com>). Start the software on his/her PC at the same time, in order to provide support and take control of the tablet remotely.
4. Provide your ID to the partner, and wait for him/her to send you a remote control request.
5. A message displays to ask for your confirmation to allow remote control on your

device.

6. Tap **Allow** to accept, or tap **Deny** to reject.

Refer to the associated TeamViewer documents for additional information.

11. Data Manager

The Data Manager application is used to store, print, and review the saved files. Most operations are controlled through the toolbar.

Selecting the Data Manager application opens the file system menu. Different file types are sorted separately under different options, there are six types of information files to be viewed or played back.



Figure 11-1 Sample Data Manager Main Screen

Operations

Data Manager Operations are based on toolbar controls. Details are explained in the following sections.

Image

The Image section contains all captured screenshot images.



Figure 11-2 Sample Image Screen

1. **Toolbar Buttons** — used to edit, print and delete the image files. See the following table for detailed information.
2. **Main Section** — displays the stored images.

Table 11-1 Toolbar Buttons in Image

| Button | Name | Description |
|--------|-------------------|---|
| | Back | Return to the previous screen. |
| | Enter Edit | Tap to display the editing toolbar to print, delete or view image information. |
| | Cancel | Tap to close the editing toolbar or cancels file search. |
| | Search | Quickly locates the image file by entering the vehicle name, test path, file name or file info. |
| | Info | Tap to open a window displaying the details of the image. |
| | Print | Tap to print the selected image. For details, see Printing Setting . |
| | Delete | Tap to delete the selected image. |

- **To edit image information**

1. Tap the **Data Manager** application from the MaxiIM Job Menu.
2. Tap **Image** to access the image database.
3. Select an image to display it in full screen.
4. Tap the screen to display the editing toolbar.
5. Tap the **Info** button to open a window displaying the image information.
6. Tap the **Edit** button on the top right corner of the window. The editing screen displays.
7. Edit the image information by entering the new file name, and file information.
8. Tap **Done** to save the information and exit, or tap **Cancel** to exit without saving.

➤ **To delete selected images**

1. Tap the **Data Manager** application from the MaxiIM Job Menu.
2. Tap **Image** to access the JPG database.
3. Tap the image to display the editing toolbar.
4. Tap the **Delete** button, and then **Delete image**. The selected images will be deleted.

Report

The Report section stores diagnostics information of the vehicle and forms a diagnostics report for user to share.

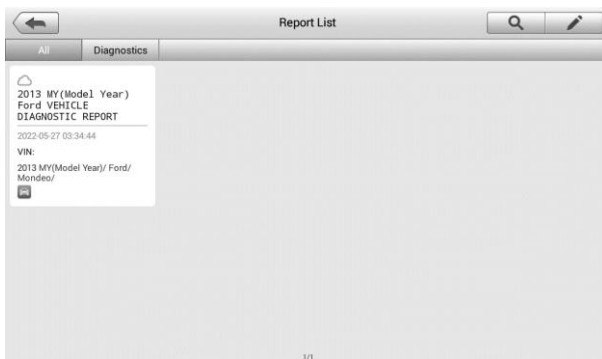

Figure 11-3 Sample Report List Screen

➤ **To share a report**

1. Tap the **Data Manager** application from the MaxiIM Job Menu.
2. Tap **Report** to access the Report List screen.

3. Tap a report record to display the Report sharing dialog box.



Figure 11-4 Sharing Report Screen 1

4. Tap **View local reports** to display it in full screen.
5. Return to the Report List screen, tap the report and tap **Report cloud sharing**.
6. Scan the QR code or tap **Send Email** or **Send SMS** to share the report.



Figure 11-5 Sharing Report Screen 2

PDF

The PDF section stores and displays all PDF files of saved data. After entering the PDF database, select a PDF file to view the stored information.

This section uses the standard Adobe Reader application for file viewing and editing. Please refer to the associated Adobe Reader manual for more detailed instructions.

Review Data

The Review Data section allows you to playback the recorded data frames of live data streams.

On the Review Data main screen, select a record file to playback.



Figure 11-6 Sample Data Playback Screen

1. **Drop-down Toolbar** — tap the button at the top center of the screen to open the Drop-down Toolbar.
2. **Main Section** — displays the recorded data frames.
3. **Navigation Toolbar** — allows you to manipulate data playback.

Use the Navigation Toolbar buttons to playback the record data from frame to frame. Tap **Back** to exit data playback.

Apps Uninstall

This section allows you to manage the firmware applications installed on the MaxiM Diagnostics System. Selecting this section opens a managing screen, on which you can check all the available vehicle diagnostic applications.

Tap the vehicle firmware you want to delete, a blue tick at the upper right corner of the firmware will display. Tap the **Delete** button on the top bar and tap **OK** to delete the firmware from the system database.

Data Logging

The Data Logging section allows you to launch Support platform directly to view all records of all sent or unsent (saved) data loggings on the diagnostic system.









12. Shop Manager

The Shop Manager application helps you manage the workshop information, customer information records, and keep test vehicle history records, which can help in dealing with daily workshop business and improves customer service. There are three main functions available:

- Vehicle History
- Workshop Information
- Customer Manager

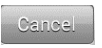
The operations of these functions are mainly manipulated by the toolbar buttons, which are listed and described in the table below:

Table 12-1 Top Toolbar Buttons in Shop Manager

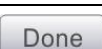
| Button | Name | Description |
|--|------------------------|--|
|  | Back | Return to the previous screen. |
|  | Diagnostics | Tap to display the Diagnostics screen to activate a direct test session. |
|  | Enter Edit | Tap to display the editing toolbar to print or delete the selected file. |
|  | Delete | Tap to delete the selected vehicle record item from the list. |
|  | Search | Quickly locates the vehicle record by entering the vehicle name or test path. |
|  | Cancel | Tap to cancel edit or file search. |
|  | Edit | Tap to edit information for the displayed file. |
|  | Add Account | Tap to create a new customer account file. |
|  | History Notes | Tap to open a note form, which allows you to create audio record, attach picture or video, or edit text notes. |
|  | Vehicle History | Tap to open the Vehicle History screen which displays the correlated test vehicle records. |
|  | Done | Complete editing and save the file. |

Vehicle History

This function stores records of test vehicle history, including vehicle information and the retrieved DTCs from previous diagnostic sessions. Test information is summarized and displayed in an easy-to-view table listing. The Vehicle History also provides direct access to the previously tested vehicle and allows you to restart a diagnostic session without the need to do vehicle identification again.

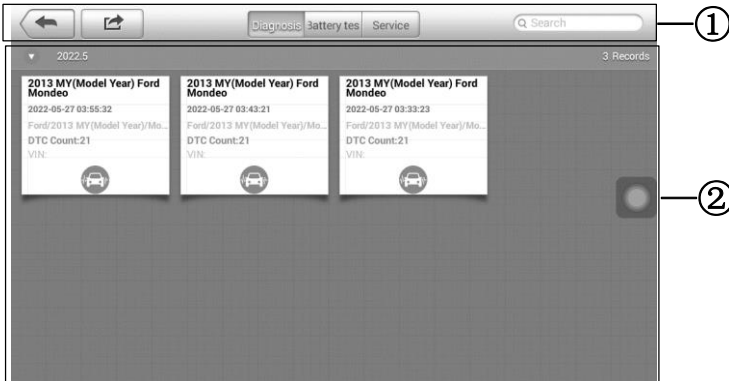
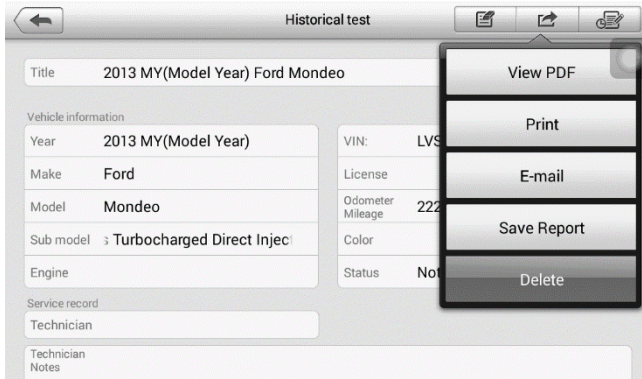

Figure 12-1 Sample Vehicle History Screen

1. **Top Toolbar Buttons** — navigation and application controls.
 2. **Main Section** — displays all the vehicle history records.
- **To activate a test session for the recorded vehicle**
1. Tap the **Shop Manager** application on the MaxiIM Job Menu.
 2. Tap **Vehicle History**
 3. Tap the **Diagnostics** button at the bottom of the thumbnail of a vehicle record item. Or,
 4. Select a vehicle record item by tapping the thumbnail.
 5. A Historical Test record sheet displays, check the recorded information of the recorded test vehicle, and tap the Diagnostics button on the upper right corner.
 6. The vehicle's Diagnostics screen displays and a new diagnostic session is activated, see [Diagnosis](#) for detailed instructions on vehicle diagnostic operations.

Historical Test Record

The Historical Test record of the tested vehicle is a detailed data form, which includes all general information of the vehicle such as vehicle year, make and model and the diagnostic trouble codes retrieved from the previous test sessions, as well as other service details that can be added manually by the technician himself.



The screenshot shows a mobile application interface titled "Historical test". At the top, there is a title field containing "2013 MY(Model Year) Ford Mondeo". Below this, the form is divided into sections: "Vehicle information" and "Service record". The "Vehicle information" section contains fields for Year (2013 MY(Model Year)), Make (Ford), Model (Mondeo), Sub model (Turbocharged Direct Injec), Engine, VIN (LVS), License, Odometer Mileage (222), Color, and Status (No). The "Service record" section has a Technician field. A menu overlay is visible on the right side of the form, containing the following options: View PDF, Print, E-mail, Save Report, and Delete.

Figure 12-2 Sample Historical Test Record Sheet

➤ To edit the Historical Test record

1. Tap the **Shop Manager** application on the MaxiIM Job Menu.
2. Tap **Vehicle History**.
3. Select the specific vehicle history record thumbnail from the main section. The Historical Test record will display.
4. Tap the **Edit** button to start editing.
5. Tap on each item to input the corresponding information or attach files or images.

NOTE

The vehicle VIN number, license number or customer account information are correlated by default. Adding one of these IDs will automatically be associated with the other ID on the test record.

6. Tap **Add to Customer** to correlate the Historical Test record sheet to an existing customer account, or add a new associated account to be correlated with the test vehicle record. See [Customer Manager](#) for more information.
7. Tap **Done** to save the updated record, or tap **Cancel** to exit without saving.

Workshop Information

The Workshop Information form allows you to input, edit, and save the detailed workshop information, such as shop name, address, phone number and other remarks, which, when printing vehicle diagnostic reports and other associated test file, will display as the header of the printed documents.

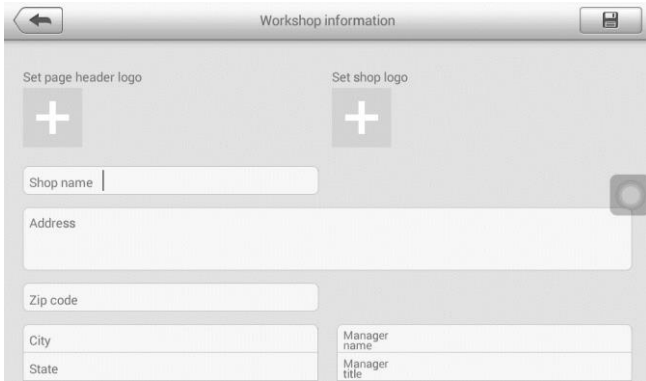

Figure 12-3 Sample Workshop Information Sheet

➤ **To edit the Workshop Information sheet**

1. Tap the **Shop Manager** application on the MaxiIM Job Menu.
2. Tap **Workshop Information**.
3. Tap the **Edit** button on the top toolbar.
4. Tap on each field to input the appropriate information.
5. Tap **Done** to save the updated workshop information record, or tap **Cancel** to exit without saving.

Customer Manager

The Customer Manager function allows you to create and edit customer accounts. It helps you to save and organize all customer information accounts that are correlated with the associated test vehicle history records.

➤ **To create a customer account**

1. Tap the **Shop Manager** application on the MaxiIM Job Menu.
2. Tap **Customer Manager**.
3. Tap the **Add Account** button. An empty information form displays, tap each field to input the appropriate information.

 **NOTE**

The items that must be filled are indicated as required fields.

4. Tap the cross mark beside the Name chart to add a photo. A sub menu displays, select **Take Photo** to take a new photo for the account, or select **Choose Photo** to choose from the existing files.
5. Some customers may have more than one vehicle for service; you can always add new vehicle information to the account. Tap **Add New Vehicle Information**, and then fill in the vehicle information. Tap the  button to cancel.
6. Tap **Done** to save the account, or tap **Cancel** to exit without saving.

➤ **To edit a customer account**

1. Tap the **Shop Manager** application on the MaxiIM Job Menu.
2. Tap **Customer Manager**.
3. Select a customer account by tapping the corresponding name card. A Customer Information record displays.
4. Tap the **Edit** button on the top toolbar to start editing.
5. Tap on the input field to edit or amend information, and enter updated information.
6. Tap **Done** to save the updated information, or tap **Cancel** to exit without saving.

➤ **To delete a customer account**

1. Tap the **Shop Manager** application on the MaxiIM Job Menu.
2. Tap **Customer Manager**.
3. Select a customer account by tapping the corresponding name card. A Customer Information record displays.
4. Tap the **Edit** button on the top toolbar to start editing.
5. Tap the **Delete Customer Information** button. A confirmation message displays.
6. Tap **OK** to confirm the command, and the account is deleted. Tap **Cancel** to cancel the request.

13. Function Viewer

The Function Viewer allows you to search the supported functions. There are two ways of searching, by vehicle or by function.

➤ **To search by the vehicle**

1. Tap the **Function Viewer** application on the MaxiIM Job Menu. The Function Viewer application screen displays.
2. Tap the tool name on the top left to drop down the tool list, tap the one you want to search.
3. Tap the vehicle brand, model, and year you want to search.



Figure 13-1 Sample Function Viewer Screen 1

4. All the functions supported by the selected tool for the selected vehicle displays with three column: function, sub function, and version.

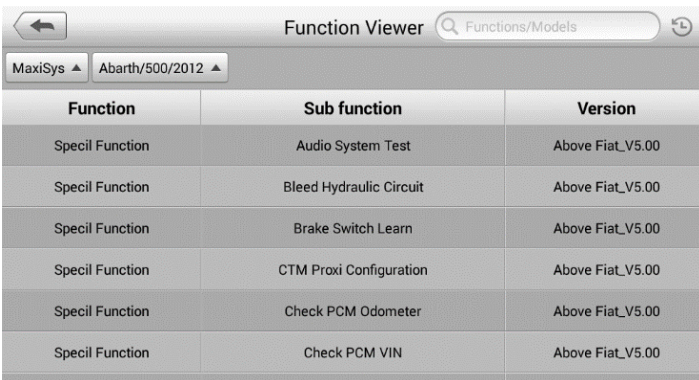

Figure 13-2 Sample Function Viewer Screen 2

➤ **To search by the functions**

1. Tap the **Function Viewer** application on the MaxilM Job Menu. The Function Viewer application screen displays.
2. Tap the tool name on the top left to drop down the tool list, tap the one you want to search.
3. Type in the function you want to search to the top right search column. All the vehicles with this function will be listed with 8 columns, the Brand, Model, Year, System, Sub system, Function, Sub function, and Version.

 **NOTE**

Fuzzy search is supported, type in part of the function you want to search for.

14. Support

This application launches the Support platform which synchronizes Autel's on-line service base station with the tablet. In order to synchronize the device to your on-line account, you need to register the product through the Internet when you use it for the first time. The Support application is connected to Autel's service channel and on-line communities which provides the quickest way for problem solutions, allowing you to submit complaints or sent help requests to obtain direct services and supports.

Product Registration

In order to get access to the Support platform and obtain update and other services from Autel, you are required to register the MaxiIM Diagnostics Device the first time you use it.

➤ To register the diagnostics device

1. Visit <http://pro.autel.com>.
2. If you already have an Autel account, sign in with your account ID and password, and skip to step 9.
3. If you are a new member to Autel, click **Register** on the left side of the screen to create your Autel ID.
4. Enter your personal information. Fields marked with an asterisk (*) are mandatory.
5. Enter your email address, then click **Request**. You will receive an email from Autel with your verification code. Open the email and copy the code into the proper input box.
6. Set a password for your account, and enter the password again to confirm.
7. Read the **Autel User Service Agreement** and **Autel Privacy Policy**, then check the box to accept the terms.
8. After all the information is entered, click **Register**. Once your account is successfully registered, you will be redirected to the Product Registration screen. If not, click the button on the screen.
9. Your product serial number and password are required to complete your registration. To find your serial number and password on the tablet: go to **Settings > About**.
10. Enter your tablet serial number and password. Enter the CAPTCHA code as shown. And click **Submit** to complete your product registration.

Support Screen Layout

The Support application screen is navigated with four simple buttons on the top navigation bar, operation of each is described below in turn from left to right:

- Home Button — returns to the MaxilM Job Menu.
- Back — press to return to the previous screen.
- Forward — press to advance one screen at a time until the last screen visited is displayed.
- Refresh — reload and update the screen.

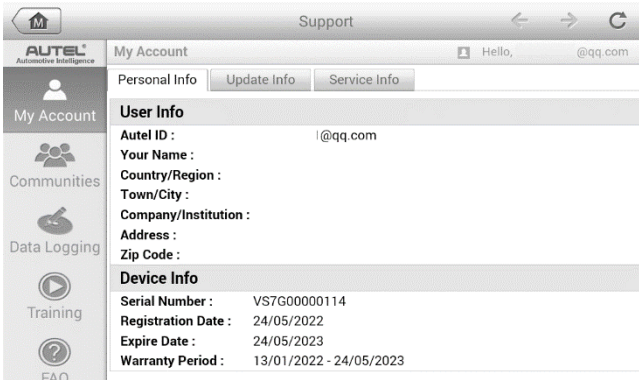

Figure 14-1 Sample Support Application Screen

The main section of the Support screen is divided into two sections. The narrow column on the left is the main menu; select a heading from the main menu to its corresponding functions on the right.

My Account

The My Account screen displays the comprehensive information of the user and the product including the user, device, update and service information, synchronized with the registered account.

Personal Info

The User Info and Device Info are both included under the Personal Info section.

- **User Info** — displays detailed information of your registered on-line Autel account, such as your Autel ID, Name, Address and other contact information.
- **Device Info** — displays the registered product information, including the Serial Number, Registration Date, Expire Date, and Warranty Period.

Update Info

The Update Info section displays a detailed record of the product's software update history, including the product serial number, software version or name, and the update time.

Service Info

The Service Info section displays a detailed record of the device's service history information. The device's service history including completed service repairs and software re-installations will be recorded and synchronized with the associated account.

Communities

The Communities section launches and synchronizes with the Technical Forums on Autel's official website www.autel.com. The community's forum allows for discussion of technical issues, the sharing of information or tips with other members in Autel's online support communities.

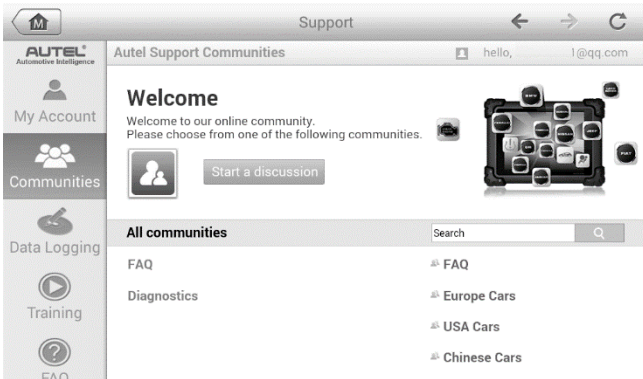



Figure 14-2 Sample Communities Home Screen

➤ To start a discussion

1. Tap **Start a discussion** on the Communities Home screen. A list of the major forums is displayed.
2. Select a desired community according to the subject you are interested in.
3. Enter your topic and the discussion content in the appropriate input field.
4. Select a category or edit tags for the discussed post. This will help other members with similar interest to find your post.
5. Tap **OK** to submit the post.

➤ To join and reply to a discussion post

1. Select a forum group either by product or feature on the Communities Home screen. A list of the latest posts is displayed.
2. Select a specific category on the Categories menu to better pinpoint the topics you are most interested in.
3. Tap the  button on the right side of the topic item to view the discussion. The posts displays.
4. Browse through all the posts by sliding the screen up and down. Tap **Go to**

original post to return to the first post.

5. Tap **Reply** to reply to a specific post, or tap **Reply to original post** to join and continue the whole discussion.
6. Enter your comment in the input field, and tap **OK** to submit your post.

Data Logging

The Data Logging section keeps records of all sent or unsent (saved) data loggings on the diagnostics system. The support personnel receive and process the submitted reports through the Support platform. Support personnel will reply to the submitted issue and corresponding Data Log session within 48 hours.

➤ To make a reply in a Data Logging session

1. Tap on the **Sent** tag to view a list of submitted data logs.
2. Select a specific item to view the latest update of the submitted issue.
3. Tap on the input field at the bottom of the screen and enter text. Tap the Audio button to record a voice message, or tap camera button to take a picture.
4. Tap **Send** to send your message to the technical center.

User Profile

The User Profile section allows you to set personal Avatar, check your member status and review your posts to the communities.

Tap the Avatar image on the Communities screen to open the User Profile.

- **Profile** — displays the user's personal information and member status. The **Related links** allow you to check the Top Users (ranked according to their points and levels) in the communities, as well as to find out about other online users.
- **Avatar** — allows you to select an image to set as an Avatar to be displayed in the communities.
- **Stuff** — displays a list of your posts in the various forums.

Training

The Training section provides quick links to Autel's online video accounts. Select a video channel by language to see all the available online tutorial videos.

FAQ

The FAQ section provides comprehensive answers to the most frequently asked questions about member accounts and online subscription purchases.

- **Account** — displays questions and answers about the use of Autel's online user account.
- **Shopping & Payment** — displays questions and answers about online subscription purchase, payment methods or procedures.

15. Academy

Autel provides various tutorials and technical bulletins written by top-notch technicians and product experts. Please review the materials on the tablet or view additional technical articles on the online forum by clicking on click on the links provided.

16. Quick Link

The Quick Link application provides access to Autel's official website and to other popular automotive service websites. These sites are invaluable resources of automotive information and repair data and include forums, video training and expert consultation.

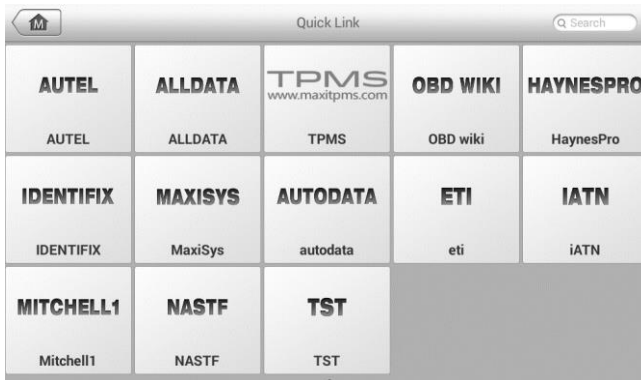

Figure 16-1 Sample Quick Link Screen

➤ **To open a quick link**

1. Tap the **Quick Link** application on the MaxiIM Job Menu. The Quick Link application screen displays.
2. Select a website thumbnail from the main section. The Chrome browser is launched and the selected website is opened.
3. Now you can start exploring the website.

17. Maintenance and Service

Maintenance Instructions

The following shows how to maintain your devices, together with precautions to take.

- Use a soft cloth and alcohol or a mild window cleaner to clean the touch screen of the tablet.
- Do not use any abrasive cleansers, detergent, or automotive chemicals to the tablet.
- Maintain the devices in dry conditions and keep them within normal operating temperatures.
- Dry your hands before using the tablet. The touch screen of the tablet may not work if the touch screen is moist, or if you tap the touch screen with wet hands.
- Do not store the devices in humid, dusty or dirty areas.
- Check the housing, wiring, and connectors for dirt and damage before and after each use.
- At the end of each work day, wipe the device housing, wiring, and connectors clean with a damp cloth.
- Do not attempt to disassemble your tablet or the VCI unit.
- Do not drop or cause severe impact to the devices.
- Use only authorized battery chargers and accessories. Any malfunction or damage caused by the use of unauthorized battery charger and accessories will void the limited product warranty.
- Ensure that the battery charger does not come in contact with conductive objects.
- Do not use the tablet beside microwave ovens, cordless phones and some medical or scientific instruments to prevent signal interference.

Troubleshooting Checklist

A. When the tablet does not work properly:

- Make sure the tablet has been registered online.
- Make sure the system software and diagnostic application software are properly updated.
- Make sure the tablet is connected to the Internet.
- Check all cables, connections, and indicators to see if the signal is being received.

B. When battery life is shorter than usual:

- This may happen when you are in an area with low signal strength. Turn off your device if it is not in use.

C. When you cannot turn on the tablet:

- Make sure the tablet is connected to a power source or the battery is charged.

D. When you are unable to charge the tablet:

- Your charger maybe out of order. Contact your nearest dealer.
- You may be attempting to use the device in an overly hot/cold temperature. Charge the device in a cooler or warmer area.
- Your device may have not been connected to the charger properly. Check the connector.

NOTE

If the problems persist, please contact Autel's technical support personnel or your local selling agent.

About Battery Usage

Your tablet is powered by a built-in Lithium-ion Polymer battery. This means that, unlike other forms of battery technology, you can recharge your battery while some charge remains without reducing your tablet's autonomy due to the "battery memory effect" inherent in those technologies.

DANGER

- The built-in Lithium-ion Polymer battery is factory replaceable only; incorrect replacement or tampering with the battery pack may cause an explosion.
 - Do not use a damaged battery charger.
 - Do not disassemble or open crush, bend or deform, puncture or shred.
 - Do not modify or remanufacture, attempt to insert foreign objects into the battery, expose to fire, explosion or another hazard.
 - Use only the included charger and USB cables. Failure to use Autel-authorized charger and/or USB cables, may result in device malfunction or failure.
 - Use of an unqualified battery or charger may present a risk of fire, explosion, leakage, or another hazard.
 - Avoid dropping the tablet. If the tablet is dropped, especially on a hard surface, and the user suspects damage, take it to a service center for inspection.
 - The closer you are to your network's wireless router, the longer your tablet usage time because less battery power is consumed for the connection.
 - The battery recharging time varies depending on the remaining battery capacity.
 - Battery life inevitably shortens over time.
 - Since overcharging may shorten battery life, remove the tablet from its charger once it is fully charged. Unplug the charger, once charging is complete.
 - Leaving the tablet in hot or cold places, especially inside a car in summer or winter, may reduce the capacity and life of the battery. Always keep the battery within normal temperatures.
-

18. Compliance Information

FCC Compliance

FCC ID: WQ8-1610MX808

This device complies with Part 15 of the FCC rules and Industry Canada's license-exempt RSSs. Operation is subject to the following two conditions:

1. This device may not cause harmful interference.
2. This device must accept any interference received, including interference that may cause undesired operation.

Cet appareil est conforme aux CNR exempts de licence d'Industrie Canada. Son fonctionnement est soumis aux deux conditions suivantes:

1. Ce dispositif ne peut causer des interférences; et
2. Ce dispositif doit accepter toute interférence, y compris les interférences qui peuvent causer un mauvais fonctionnement de l'appareil.

WARNING

Changes or modifications not expressly approved by the party responsible for compliance could void the user's authority to operate the equipment.

NOTE

This equipment has been tested and found to comply with the limits for a Class B digital device, pursuant to Part 15 of the FCC Rules. These limits are designed to provide reasonable protection against harmful interference in a residential installation.

This equipment generates uses and can radiate radio frequency energy and, if not installed and used in accordance with the instructions, may cause harmful interference to radio communications. However, there is no guarantee that interference will not occur in a particular installation. If this equipment does cause harmful interference to radio or television reception, which can be determined by turning the equipment off and on, the user is encouraged to try to correct the interference by one or more of the following measures:

- Reorient or relocate the receiving antenna.
- Increase the separation between the equipment and receiver.
- Connect the equipment into an outlet on a circuit different from that to which the receiver is connected.
- Consult the dealer or an experienced radio/TV technician for help.

Changes or modifications not expressly approved by the party responsible for compliance could void the user's authority to operate the equipment.

SAR

The radiated output power of this device is below the FCC radio frequency exposure limits. Nevertheless, the device should be used in such a manner that the potential for human contact is minimized during normal operation.

The exposure standard for wireless devices employs a unit of measurement known as the Specific Absorption Rate, or SAR. The SAR limit set by the FCC is 1.6 W/Kg. Tests for SAR are conducted using standard operating positions accepted by the FCC with the device transmitting at its highest certified power level in all tested frequency bands.

Although the SAR is determined at the highest certified power level, the actual SAR level of the device while operating can be well below the maximum value. This is because the device is designed to operate at multiple power levels so as to use only the power required to reach the network. To avoid the possibility of exceeding the FCC radio frequency exposure limits, human proximity to antenna should be minimized.

RF WARNING STATEMENT

The device has been evaluated to meet general RF exposure requirement. The device can be used in portable exposure condition without restriction.

The term "IC" before the radio certification number only signifies that IC technical specifications were met.

RoHS COMPLIANCE

This device is declared to be in compliance with the European RoHS Directive 2011/65/EU.

CE COMPLIANCE

This product is declared to conform to the essential requirements of the following Directives and carries the CE mark accordingly:

EMC Directive 2014/30/EU

R&TTE Directive 1999/5/EC

Low Voltage Directive 2014/35/EU

19. Warranty

Limited One Year Warranty

Autel Intelligent Technology Corp., Ltd. (the Company) warrants to the original retail purchaser of this MaxilM Diagnostic Device, that should this product or any part thereof during normal consumer usage and conditions, be proven defective in material or workmanship that results in product failure within one (1) year period from the date of purchase, such defect(s) will be repaired, or replaced (with new or rebuilt parts) with Proof of Purchase, at the Company's option, without charge for parts or labor directly related to the defect(s).

The Company shall not be liable for any incidental or consequential damages arising from the use, misuse, or mounting of the device. Some states do not allow limitation on how long an implied warranty lasts, so the above limitations may not apply to you.

This warranty does not apply to:

- a) Products subjected to abnormal use or conditions, accident, mishandling, neglect, unauthorized alteration, misuse, improper installation or repair or improper storage;
- b) Products whose mechanical serial number or electronic serial number has been removed, altered or defaced;
- c) Damage from exposure to excessive temperatures or extreme environmental conditions;
- d) Damage resulting from connection to, or use of any accessory or other product not approved or authorized by the Company;
- e) Defects in appearance, cosmetic, decorative or structural items such as framing and non-operative parts.
- f) Products damaged from external causes such as fire, dirt, sand, battery leakage, blown fuse, theft or improper usage of any electrical source.

! IMPORTANT

All contents of the product may be deleted during the process of repair. You should create a back-up copy of any contents of your product before any repair services.
