

## Trademarks

Autel, MaxiSys, MaxiCheck, MaxiDAS, MaxiDiag, MaxiRecorder, MaxiScan, and MaxiTPMS are trademarks of Autel Intelligent Technology Corp., Ltd., registered in China, the United States and other countries. All other marks are trademarks or registered trademarks of their respective holders.

## Copyright Information

No part of this manual may be reproduced, stored in a retrieval system or transmitted, in any form or by any means, electronic, mechanical, photocopying, recording, or otherwise, without the prior written permission of Autel.

## Disclaimer of Warranties and Limitation of Liabilities

All information, specifications and illustrations in this manual are based on the latest information available at the time of printing.

Autel reserves the right to make changes at any time without notice. While information of this manual has been carefully checked for accuracy, no guarantee is given for the completeness and correctness of the contents, including but not limited to the product specifications, functions, and illustrations.

Autel will not be liable for any direct damages or for any special, incidental, or indirect damages or for any consequential economic damages.

---

## ! IMPORTANT

Before operating or maintaining this unit, please read this manual carefully, paying extra attention to the safety warnings and precautions.

---

## For Services and Support



<http://pro.autel.com>  
[www.autel.com](http://www.autel.com)



1-855-288-3587/1-855-AUTEL US (North America)  
0086-755-86147779 (China)



[Support@autel.com](mailto:Support@autel.com)

For technical assistance in all other markets, please contact your local selling agent.

# Safety Instructions

To prevent personal injury or damage to vehicles and/or the inspection tool, read this instruction manual first and observe the following safety precautions at a minimum whenever working on a vehicle.

## Work Area Safety

---

- Always perform automotive testing in a safe environment.
- Keep clothing, hair, hands, tools, test equipment, etc. away from all moving or hot engine parts. The cable shall be operated under 60 °C (140 °F).
- Operate the tool in a well-ventilated work area.
- Do not operate the tool in a potentially combustible atmosphere, such as in the presence of flammable liquids, gases, or heavy dust.
- Keep a fire extinguisher for use on gasoline/chemical/electrical fires nearby.
- Do not use the tool around corrosive chemicals.
- Keep bystanders, children and visitors away vehicle testing area.
- Keep the tool dry, clean, free from oil, water and grease. Use a mild detergent on a clean, damp cloth to clean the outside of the tool when necessary.

## Electrical Safety

---

- Keep the tool away from grounded surfaces such as pipes, radiators, ranges and refrigerators.
- Do not expose the tool to rain or wet conditions. Water entering the tool will increase the risk of electric risk.

- Do not unplug the tool from the electrical outlet by pulling on electrical cord. Never carry tool by cord. Keep cord away from heat, oil, sharp edges or moving parts.
- If operating the tool in a damp location is unavoidable, use a ground fault circuit interrupter (GFCI) to protect the tool from damage and the operator from injury.

## **Personal Safety**

---

- Do not use the tool while tired or under the influence of drugs, alcohol, or medications. A moment of distraction can result in serious personal injury.
- Do not over-reach. Keep proper footing and balance at all times. Proper footing and balance enable better control of the tool in unexpected situations.
- Always wear safety eye protection that meets ANSI standards.
- Do not wear loose clothing or jewelry. Keep your hair, clothing, and gloves away from moving parts.
- Do not place the tool on any unstable cart or surface. The tool may fall causing serious injury to a person or serious damage to the tool itself.
- Do not have liquids near the tool. Liquid increases the risk of electric shock and damage to the tool.
- Do not use the tool for personal or medical use.
- The product is not shock-resistant. Handle it with care and be careful not to drop it.

# Contents

<b>SAFETY INSTRUCTIONS</b> .....	<b>II</b>
<b>WORK AREA SAFETY</b> .....	<b>II</b>
<b>ELECTRICAL SAFETY</b> .....	<b>II</b>
<b>PERSONAL SAFETY</b> .....	<b>III</b>
<b>1. USING THE MANUAL</b> .....	<b>1</b>
<b>CONVENTIONS</b> .....	<b>1</b>
<b>2. GENERAL INTRODUCTION</b> .....	<b>3</b>
<b>2.1 DESCRIPTION</b> .....	<b>3</b>
<b>2.2 SPECIFICATIONS</b> .....	<b>3</b>
<b>2.3 ACCESSORIES INCLUDED</b> .....	<b>4</b>
<b>2.4 TOOL COMPONENTS AND PORTS</b> .....	<b>5</b>
<b>2.5 BUTTONS AND CONTROLS</b> .....	<b>8</b>
<b>3. INSTALLATION AND CONNECTION</b> .....	<b>9</b>
<b>3.1 THE IMAGER HEAD AND CABLE INSTALLATION</b> .....	<b>9</b>
<b>3.2 ACCESSORIES INSTALLATION</b> .....	<b>9</b>
<b>3.3 MINI USB CABLE CONNECTION</b> .....	<b>10</b>
<b>4. BATTERY CHARGING PRECAUTIONS</b> .....	<b>11</b>
<b>4.1 BATTERY CHARGING SAFETY</b> .....	<b>11</b>
<b>4.2 BATTERY AND CHARGER SPECIFICATIONS</b> .....	<b>11</b>

4.3 CHARGER INSPECTION .....	12
4.4 BATTERY CHARGING PROCEDURES.....	12
<b>5 OPERATION INSTRUCTIONS.....</b>	<b>14</b>
5.1 OPERATION PRECAUTIONS .....	14
5.2 APP INSTALLATION AND START .....	15
5.3 ON-SCREEN NAVIGATION.....	16
FIGURE 5-5 <i>AUTEL MAXIVIDEO MAIN SCREEN</i> .....	16
5.4 SETTINGS.....	19
<b>6 FIRMWARE UPGRADE .....</b>	<b>24</b>
6.1 UPGRADE ON APP .....	24
6.2 REPAIR FROM PC .....	25
<b>7 TROUBLESHOOTING.....</b>	<b>26</b>
TABLE 7-1 <i>TROUBLESHOOTING</i> .....	26
<b>8 COMPLIANCE INFORMATION.....</b>	<b>27</b>
<b>9 WARRANTY INFORMATION.....</b>	<b>28</b>
9.1 LIMITED ONE YEAR WARRANTY.....	28
9.2 SERVICE PROCEDURE.....	28

# 1. Using the Manual

This manual contains device usage instructions.

Some illustrations shown in this manual may depict tool models and/or optional equipment that are not included on or with your system. Contact your sales representative for availability of tool options or accessories not included.

## Conventions

The following conventions are used.

### Bold Text

Bold text is used to highlight selectable items such as buttons and menu options.

Example:

- Press the **Power** button.

### Notes and Important Messages

#### *Notes*

A **NOTE** provides helpful information such as additional explanations, tips, and comments.

Example:

---

#### **NOTE**

New batteries reach full capacity after approximately 3 to 5 charging and discharging cycles.

---

#### *Important*

**IMPORTANT** indicates a situation which, if not avoided, may result in damage to the test equipment or vehicle.

Example:

---

**! IMPORTANT**

Keep the cable away from heat, oil, sharp edges and moving parts. Replace damaged cable immediately.

---

## **Hyperlinks**

Hyperlinks or links that take you to other related articles, procedures, and illustrations are available in electronic documents. Blue italic text indicates a selectable hyperlink.

## **Illustrations**

Illustrations used in this manual are samples, the actual testing screen may vary for each vehicle being tested. Observe the menu titles and on-screen instructions to make correct option selection.

## 2. General Introduction

### 2.1 Description

This premier Autel MaxiVideo MV160 is the next generation of digital videoscope designed for smartphones. It features a two-megapixel high-resolution camera and a standard 8.5mm camera probe, which makes it easy to inspect difficult-to-reach areas with its semi-rigid flexible cable and 10-level adjustable LED light. MV160 works perfectly with both Android and iOS smartphones. With the Autel MaxiVideo app, you can connect the videoscope to your smartphone via Wi-Fi and edit photos, videos, and voice recordings directly on your phone, and share with your customers and colleagues. The multipurpose videoscope is an economical solution to inspect machinery, facilities, and infrastructure in the safest and most cost-effective manner possible.

This manual describes the construction and operation of the device and how it works to examine difficult-to-reach areas.

### 2.2 Specifications

<b>Recommended use</b>	Indoor
<b>Optimal viewing Distance</b>	0.79" to 2" (2 cm to 5 cm)
<b>Image capture</b>	JPG images (Max:1920 x 1080 pixels) MP4 videos (Max:1920 x 1080 pixels)
<b>Power supply</b>	Built-in rechargeable lithium-ion battery pack (3.7V/2600mAh)



<b>Tested battery life</b>	Approximately 4 hours of continuous use
<b>Dimensions</b>	237 x 63 x 123mm (9.33" x 2.48" x 4.84")
<b>Weight</b>	0.309 kg (0.68lbs)
<b>Recording medium</b>	Android & iOS smartphone
<b>Image controls</b>	Zoom; Flip/Rotate; Color/ Monochrome
<b>Lighting</b>	Fully adjustable LED; Flashlight
<b>Cable reach</b>	1m (39.4")
<b>Imager head</b>	8.5mm (0.33"), 2 megapixel (1920 x 1080 pixels)
<b>Waterproof</b>	To a depth of 1m (39.4") (Imager heads and cable only)
<b>Additional ports</b>	Mini USB
<b>Operating temp.</b>	Main unit: 14 °F to 122 °F (-10 °C to 50 °C); Cable: 14 °F to 140 °F (-10 °C to 60 °C)
<b>Storage temp.</b>	-4 °F to 158 °F (-20 °C to 70 °C)
<b>Operating humidity</b>	5% - 95% non-condensing

## 2.3 Accessories Included

- 1) Imager Head and Cable (8.5mm)
- 2) Magnet, Hook, Mirror
- 3) Charger
- 4) Mini USB Cable
- 5) User Manual

## 2.4 Tool Components and Ports

The MaxiVideo MV160 comes with the following items:

---

ⓘ **NOTE**

Because of continuing improvements and modifications, actual product may differ slightly from photo.

---

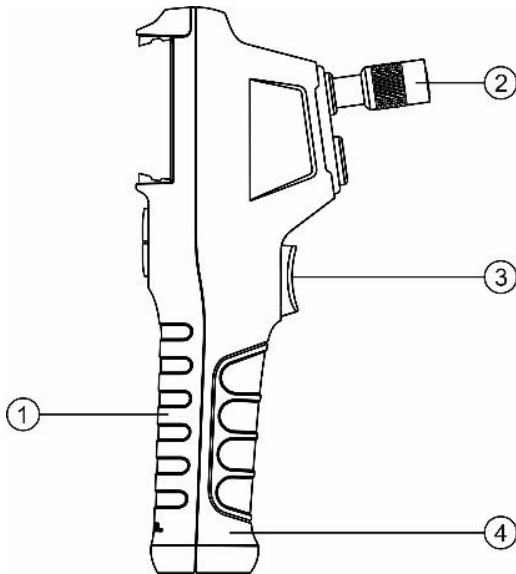

**Figure 2-1** MaxiVideo MV160 Right Side View

1. Handheld Unit – Ergonomic tool with comfortable pistol grip design.
2. Knurled knob – Fastens the handheld unit with the imager head cable.
3. Shoot Button – Takes photos, starts and stops video recording; Press and hold to take multiple photos.
4. Battery Compartment Cap – Covers the battery in the handle.

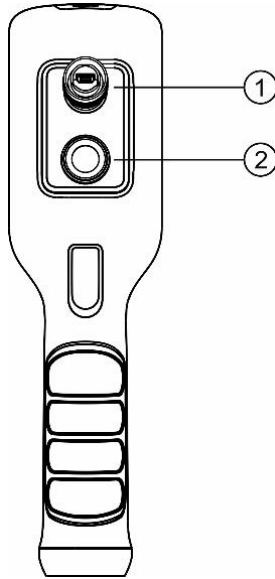

**Figure 2-2** *MaxiVideo MV160 Back Side View*

1. USB Port – Connects the handheld unit to the imager head and cable.
2. Flashlight – Illuminates low light environment.

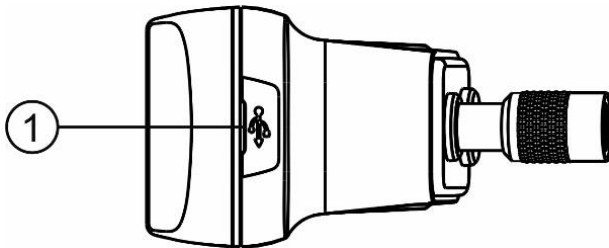

**Figure 2-3** *MaxiVideo MV160 Top View*

1. Mini USB/Power Source Port – Connects the tool to a computer with the supplied Mini USB cable for battery charging or firmware updating. Connects the tool with the supplied Mini USB cable and charger to power on the tool or to charge battery.

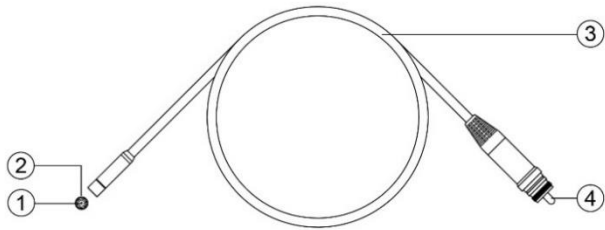

**Figure 2-4** *MaxiVideo MV160 Cable and Imager Head*

1. Imager Head
2. LED Light
3. Cable
4. Alignment Key

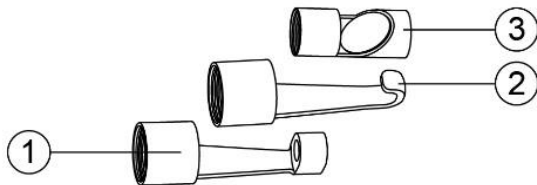
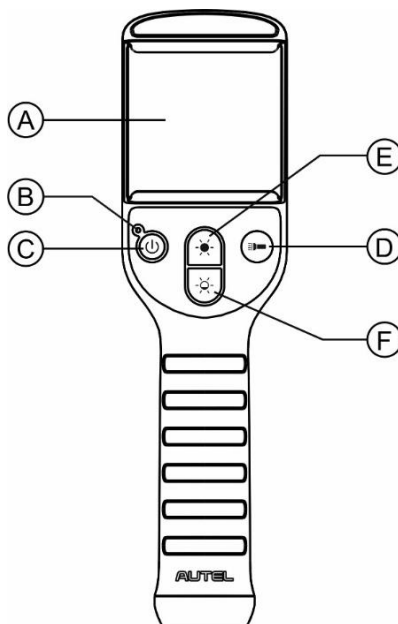

**Figure 2-5** *MaxiVideo MV160 Accessories*

1. Accessory Magnet – Attaches to tool to pick up small metal objects such as screws.
2. Accessory Hook – Attaches to tool to pick up wires or rings in pipes or confined areas.

3. Accessory Mirror – Attaches to tool to inspect corners and unreachable areas.

## 2.5 Buttons and Controls



**Figure 2-6** MaxiVideo MV160 Buttons and Controls

- A. Smartphone Mount – Clamps your smartphone.
- B. Power LED – Lights yellow when charging, lights green when powering on or charging is complete, and lights red when the battery falls below 15 percent.
- C. Power Button – Powers tool on and off.
- D. Flashlight Button – Turns flashlight on and off.
- E. LED Brighter Button – Increases imager head LED brightness.
- F. LED Dimmer Button – Decreases imager head LED brightness.

## 3. Installation and Connection

### 3.1 The Imager Head and Cable Installation

To use the tool, the imager head and cable must be connected to the handheld unit. To connect the cable to the handheld unit, align the key on the probe connector with slot on the coupling (Figure 3-1). Push the two ends together and, finger-tighten the collar to hold the connection firmly in place.

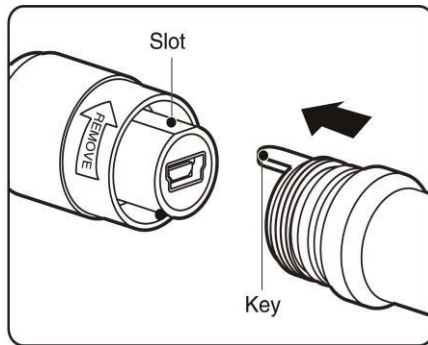

**Figure 3-1** *Connect Imager with Cable*

### 3.2 Accessories Installation

Three accessories are included: a magnet, a hook, and a mirror (Figure 2-5). All are attached to the imager head in the same manner. Detach the cap from the imager head as shown in Figure 3-2 and Figure 3-3. Slip the end of the accessory over the imager head and then secure the accessory as shown in Figure 3-4 and Figure 3-5.

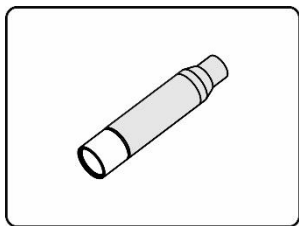

Figure 3-2

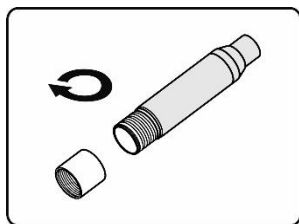

Figure 3-3

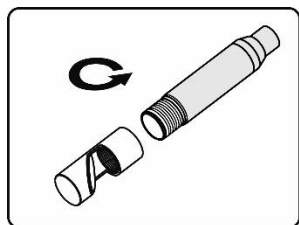

Figure 3-4

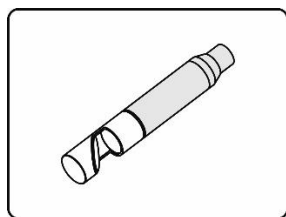

Figure 3-5

### 3.3 Mini USB Cable Connection

Use the supplied Mini USB cable to connect the tool to a PC for charging or firmware upgrading. For firmware upgrading, please refer to 6.2.

## 4. Battery Charging Precautions

---

### ❗ IMPORTANT

To reduce the risk of serious injury, read these precautions and specification label on charger carefully before using.

---

### 4.1 Battery Charging Safety

- Do not probe charger with conductive objects.
- Do not use charger if it has been damaged.
- Charge battery in temperatures above 41 °F (5 °C) and below 113 °F (45 °C).
- Keep charger out of the reach of children.
- Use only the charger supplied.
- Do not charge the battery for more than 24 hours.
- Do not cover the charger while in use.
- Do not clean charger while it is plugged into electrical outlet.
- Do not store charger in damp, wet area or with corrosive liquids.
- Do not open charger housing. Do not attempt to repair.
- Do not charge battery near fire or in the sunlight or in direct heat.
- Proper care will prevent serious damage to the charger.

### 4.2 Battery and Charger Specifications

<b>Input</b>	USB-5V
<b>Battery Type</b>	3.7V lithium-ion
<b>Battery Capacity</b>	2600mAh



<b>Input Current</b>	1A Max (USB)
<b>Charging Time</b>	3-4 hours

## 4.3 Charger Inspection

### ! IMPORTANT

Before using, inspect the charger for any damage. Set up charger according to these procedures to reduce the risk of injury to persons and tool. Inspect the charger for damage or modifications including broken, worn, missing, misaligned or binding parts. Do not use charger if damaged. The warning label on charger's surface is intact and readable.

- The tool should only be charged in an appropriate workspace, with a temperature of between 41 °F (5 °C) and 113 °F (45 °C). If the temperature is out of this range at any point during charging, the operation will be suspended.
- The charger should plug correctly into the desired electrical outlet.
- The charger should have a clearance of at least 4" (10 cm) on all sides so as not to overheat.

## 4.4 Battery Charging Procedures

The tool has a 3.7V built-in rechargeable lithium-ion battery. If the battery level is too low to continue operating, the tool will automatically shut off.

There are two battery charging methods:

- 1) To charge battery by charger and Mini USB cable: Plug the supplied Mini USB cable into the tool and into the charger hub and plug the charger into the electrical outlet.

- 2) To charge battery by computer: Plug the supplied Mini USB cable into the tool and connect the cable to a USB port on a powered-on computer.
- The battery will begin charging automatically. While the battery is charging, the charging indicator will light yellow.
  - When the battery is fully charged, the charging indicator will light green.
  - Once the battery is charged, it may remain charged until it is ready to be used. When the battery has been fully charged, the charger automatically switches to retention charging.
  - Unplug charger from outlet once charging completes.

---

ⓘ **NOTE**

New battery reaches full capacity after approximately 3 to 5 charging and discharging cycles. The Power LED light might appear abnormal when the tool is turned on/off during charging.

---

# 5 Operation Instructions

## 5.1 Operation Precautions

- Use the tool strictly according to the user manual.
- Do not submerge the imager head and cable in water or any corrosive, oily substance to prevent electric shock and tool damage. Always keep your hands dry when using the tool.
- Keep the tool away from heat sources such as radiators and stoves or areas where the temperature is higher than 122 °F (50 °C).
- Do not place the imager head and cable near a live electric charge or moving parts to prevent electric shock or entanglement injuries.
- Do not use excessive force to insert or withdraw the imager head and cable. Disassembling the tool will void the warranty.
- Do not use the imager head and cable to clear or unclog inspection areas.
- When using the tool in the following scenarios:
  - FOR WALLS:** Turn off the circuit breaker to the building before inspecting the inside of walls.
  - FOR PIPES:** Do not inspect a metal pipe if you suspect the pipe is electrified.
  - FOR AUTOMOBILES:** Always wear eye protection. Ensure the automobile is not running during the inspection to protect the imager head and cable from damaged or smeared.
- This is not a medical tool. Do not use the tool for personal inspection or medical use.
- Only use Autel-approved accessories with this tool.

## 5.2 App Installation and Start

Before using MV160, you need to download and install the Autel MaxiVideo app to your smartphone. You can go to your App Store or Google Play, or scan the QR code below to get the iOS or Android version of the app.



**Figure 5-1** QR Code for Downloading Autel MaxiVideo App



**Figure 5-2** Autel MaxiVideo App Icon

This done, press and hold the power button on the MV160 panel to turn on the tool, which then creates a WLAN network named “MV160-xxxxx” for communication with your smartphone.

From your smartphone, join the above WLAN network with the default password “12345678”. When connection is secured, tap the icon to enter the application. The following is the boot page.



**Figure 5-3** *Boot Page*

The following page appears for you to choose whether to take an image (tap the camera icon) or to view existing documents (tap the documents icon).

















**Figure 5-4** *Function Selection*

## 5.3 On-screen Navigation

### 5.3.1 Main Screen



**Figure 5-5** *Autel MaxiVideo Main Screen*

1.  Settings – includes settings such as those of Shutter sound, Time watermark, Rotate mode, Auto shutdown, Resolution, Restore settings, Channel switch, Historical records, About and Firmware upgrade.
2.  Edit Screen Print – tap to capture the current image and enter the **Image Processing** page, where you can add marks of different shapes and colors as well as text to the captured image.
3.  Color Mode – tap to switch between colorful and black-and-white modes.
4.  Rotate Mode – tap to switch between flip and rotation modes.
5.  Brightness – tap or slide to adjust the imager head LED brightness.
6.  Zoom – tap to gradually enlarge the target object from one to seven times.
7.  Battery – shows power remaining in the MV160 battery.
8.  Flashlight – displays when the flashlight on the back of the tool is on.
9.  Document Manager – tap to view the images or videos shot and stored.
10.  Shoot – tap to capture an image or to start and finish recording a video.
11.  Record – tap to start recording a video.
12.  Pause – tap to pause recording a video.
13.  Image/video Toggle – tap to switch between image and video modes.
14.  Resolution – tap to switch between 1920\*1080 pixels and 1280\*720 pixels with the 2 megapixel imager head, or switch to 1280\*720 pixels with the one megapixel imager head.
15.  Wi-Fi Connection – displays when network connection is poor.

### 5.3.2 Take an Image

The main screen shows what the front camera captures. You can zoom in or out and adjust the LED brightness to locate the desired part. All set, tap the **Shoot** button to the right of the screen or pull the button on the back of the tool to take an image.

### 5.3.3 Edit the Image

The image taken is automatically stored in the tool. You can tap the **Document Manager** button in the bottom right corner to view all the images and videos. Choose the image you want to edit, and the **Image Review** screen displays.



**Figure 5-6** *Image Review Screen*

You can perform the following operations on this screen:

1. View image Information – tap the **Image Information** button to

view information including the image name, time of capture, and image size.

2. Add audio comment – tap the **Audio Comment** button and press the red-and-white **Record** button to add an audio note to the image.

3. Process image – tap the **Image Processing** button to add marks of different shapes and colors as well as text annotation.

4. Delete image – tap the **Delete** button and confirm to delete the current image.

5. Share image – tap the **Share** button in the top right corner to share the image via whatever means your smartphone supports.

### 5.3.4 Record a Video

To record a video, tap the **Image/video Toggle** to switch to the video recording mode. After setting the parameters, tap the red-and-white button at the bottom of the screen or pull the button on the back of the tool to start the recording and tap again to finish. You can adjust the brightness and zoom in or out during the recording. The recorded video is automatically saved and can be shared or deleted in the **Video Playback** screen of **Document Manager**.

## 5.4 Settings

The **Settings** screen includes settings such as those of shutter sound, time watermark, rotate mode and auto shutdown, as shown in the following figure.



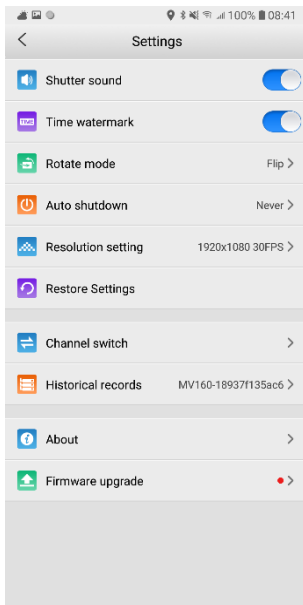

**Figure 5-7** Settings

### 5.4.1 Shutter Sound

You can toggle on/off the shutter sound, which is opened by default.

### 5.4.2 Time Watermark

You can toggle on the time watermark function to automatically add time watermark to each image or video you take.

### 5.4.3 Rotate Mode

You can choose to display either the **Flip** or **Rotate** button on the main screen.

### 5.4.4 Auto Shutdown

You can choose to shut down the tool in 3 or 5 min if no operation is performed, or simply disable the auto shutdown function by default.

## 5.4.5 Resolution Setting

You can choose between 1920\*1080 pixels and 1280\*720 pixels with the 2 megapixel imager head, or switch to 1280\*720 pixels with the one megapixel imager head.

## 5.4.6 Restore Settings

Tap to revoke changes to the above settings. When the confirmation notification displays, tap **OK** to restore the settings.

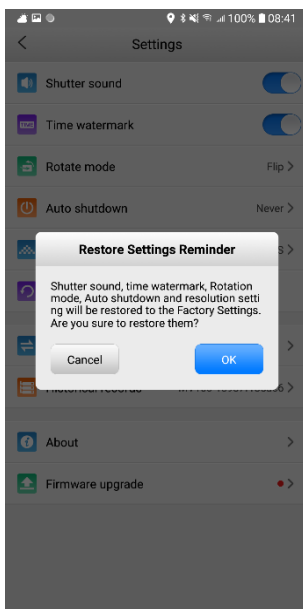

**Figure 5-8** *Restore Settings*

## 5.4.7 Channel Switch

When communication between the tool and your smartphone is unstable, or the transmission of image/video data is not smooth, tap to select another channel that is less crowded.

You may change the region under Channel Switch. It is recommended

that you should use the system default region. If modifying the region causes failure to find the handle hotspot, press and hold the flashlight button on the handle for about 20 seconds to reset the system default region. The power indicators turns off and on again if the reset is successful.

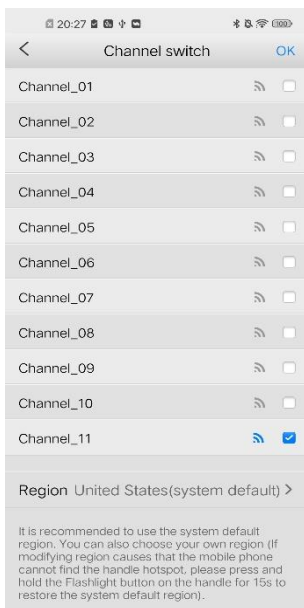

**Figure 5-9** Channel Switch

## 5.4.8 Historical Records

Tap to view records of access to the tool, including access time and serial number, as shown in the following figure.

Historical records

MV160-18937f135ac6	00.00.15	▼
MV160-18937f135ac6	00.00.15	▼
MV160-18937f135ac6	00.00.15	▼
MV160-18937f135ac6	00.00.15	▼
MV160-18937f135ac6	00.00.15	▼
MV160-18937f135ac6	00.00.15	▼
MV160-18937f135ac6	00.00.15	▼
MV160-18937f135ac6	00.00.15	▲
Access time	2019-09-24 15:55:20	
Serial Number	18937f135ac6	
MV160-yg-ap6236	00.00.19	▼
MV160-18937f135ac6	00.00.15	▼
MV160-18937f135ac6	00.00.15	▼
MV160-18937f135ac6	00.00.15	▼

**Figure 5-10** *Historical Records*

## 6 Firmware Upgrade

You can upgrade the MV160 firmware directly on the app or from your PC.

### 6.1 Upgrade on App

In **Settings**, tap **Firmware Upgrade** to display the following page.

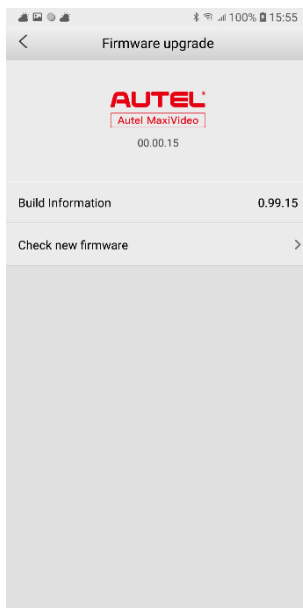

**Figure 6-1** *Firmware Upgrade Screen*

Tap **Check new firmware** to check if upgrades are available. If so, a window displays to guide you through the upgrade operations.

## 6.2 Repair from PC

Please download the Maxi PC Suite from [www.autel.com](http://www.autel.com), and install to your Windows-based computer. Run the Maxi PC Suite. The repair interface is shown in the following figure.



**Figure 6-2** *MV160 Repair Interface*

When the MV160 tool is shut down, connect it to your PC with the Mini USB cable supplied. Press the **LED Brighter** button and the **Power** button in sequence to enter the firmware upgrade mode. In the repair interface, click the Repair button to repair the device only when necessary.

# 7 Troubleshooting

**Table 7-1** *Troubleshooting*

<b>Symptoms</b>	<b>Possible Cause</b>	<b>Solution</b>
Display is on, but no image is shown.	Cable connection is loose.	Check and reattach.
	Imager head is covered.	Ensure the imager head is not covered.
The imaging is dim even if tuned to the max brightness, and the tool is shut down after a short period of time.	Low battery.	Charge the battery.
The tool cannot be turned on.	Battery is dead.	Charge the battery.
Red signal icon is displayed on screen.	Network connection is poor.	<ul style="list-style-type: none"><li>● Disable and enable Wi-Fi.</li><li>● Change the screen resolution.</li><li>● Install the smartphone on the handle.</li></ul>

## 8 Compliance Information

### FCC COMPLIANCE

MVI60 complies with Part 15 of the FCC Rules. Operations are subject to the following two conditions:

1. This tool may not cause harmful interference.
2. This tool must accept any interference received, including interference that may cause undesired operations.

---

### WARNING

Changes or modifications not expressly approved by the party responsible for compliance could void the user's authority to operate the equipment.

---

### NOTE

This equipment has been tested and found to comply with the limits for a Class B digital device, pursuant to Part 15 of the FCC Rules. These limits are designed to provide reasonable protection against harmful interference in a residential installation.

---

### RoHS COMPLIANCE

This tool is declared to comply with the European RoHS Directive 2011/65/EU.

### CE COMPLIANCE

This tool is declared to conform to the essential requirements of the following Directives and carries the CE mark accordingly:

EMC Directive 2014/30/EU

RE Directive 2014/53/EU

Low Voltage Directive 2014/35/EU



## **9 Warranty Information**

### **9.1 Limited One Year Warranty**

Autel warrants to its customers that this product will be free from all defects in materials and workmanship for a period of one (1) year from the date of the original purchase, subject to the following terms and conditions:

- 1) The sole responsibility of Autel under the Warranty is limited to either the repair or, at the option of Autel, replacement of the tool at no charge with Proof of Purchase. The sales receipt may be used for this purpose.
- 2) This warranty does not apply to damages caused by improper use, accident, flood, lightning, or if the product was altered or repaired by anyone other than the Manufacturer's Service Center.
- 3) Autel shall not be liable for any incidental or consequential damages arising from the use, misuse, or mounting of the tool.
- 4) All information in this manual is based on the latest information available at the time of publication and no warranty can be made for its accuracy or completeness. Autel reserves the right to make changes at any time without notice.

### **9.2 Service Procedure**

If you have any questions, please contact your local store, distributor or visit our website at [www.autel.com](http://www.autel.com).

If it becomes necessary to return the tool for repair, contact your local distributor for more information.